

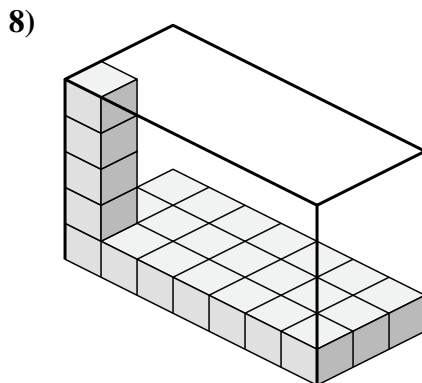

Determine the volume of each box. Each block is 1 cubic unit ( $u^3$ ).

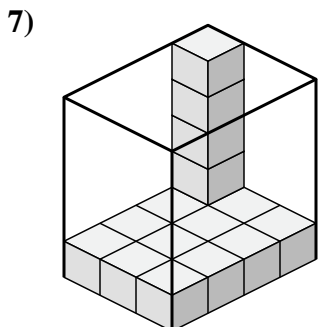
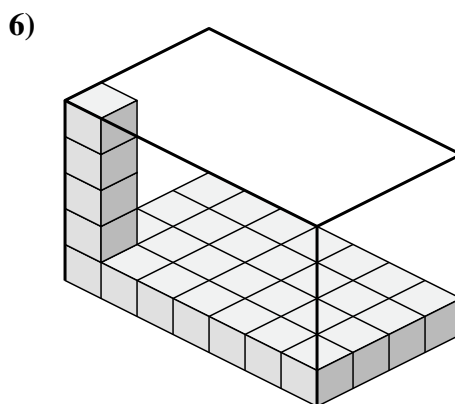
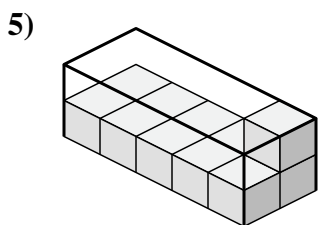
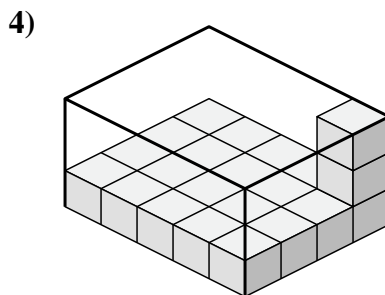
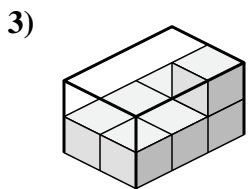
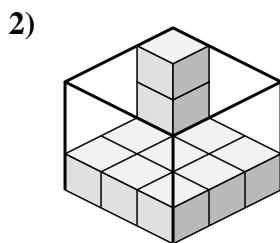
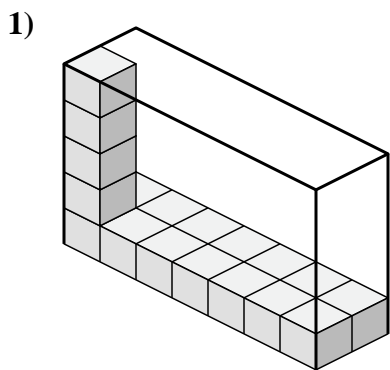

Answers

- 1. \_\_\_\_\_
- 2. \_\_\_\_\_
- 3. \_\_\_\_\_
- 4. \_\_\_\_\_
- 5. \_\_\_\_\_
- 6. \_\_\_\_\_
- 7. \_\_\_\_\_
- 8. \_\_\_\_\_



Determine the volume of each box. Each block is 1 cubic unit ( $u^3$ ).

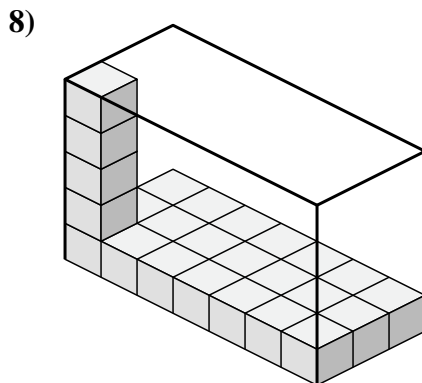
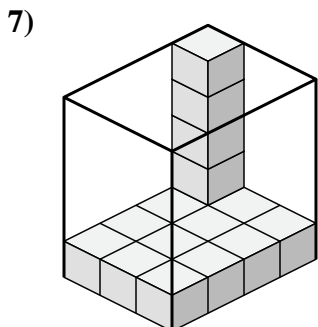
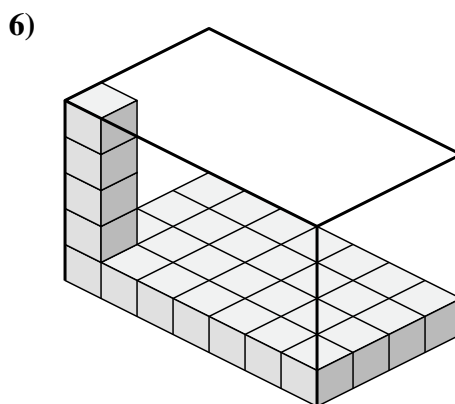
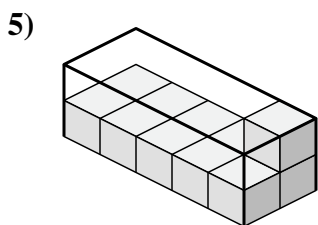
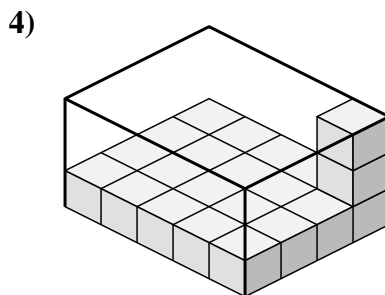
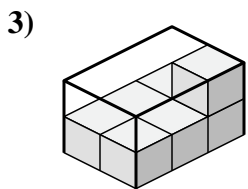
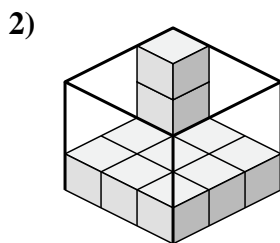
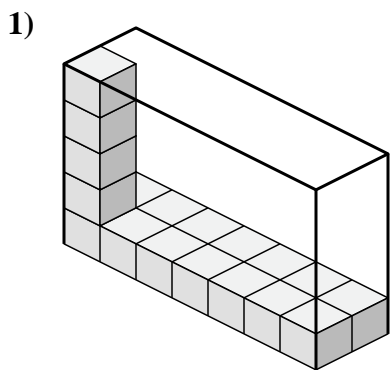

Answers

1. 70  $u^3$

2. 27  $u^3$

3. 12  $u^3$

4. 60  $u^3$

5. 20  $u^3$

6. 140  $u^3$

7. 60  $u^3$

8. 105  $u^3$