

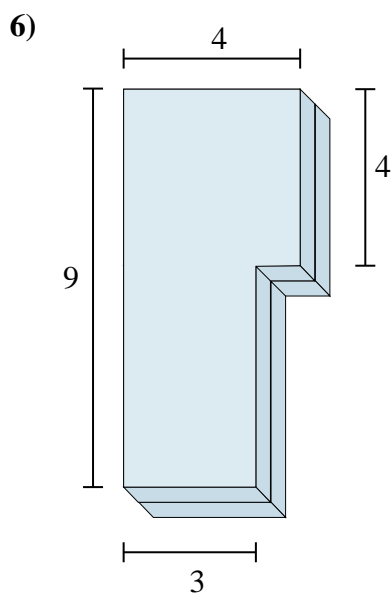

Find the total volume of each figure shown. Measured in cm (not to scale).

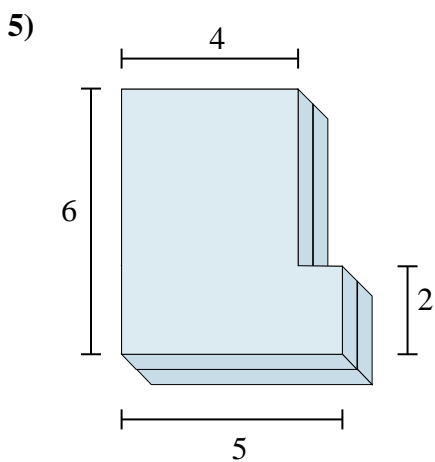
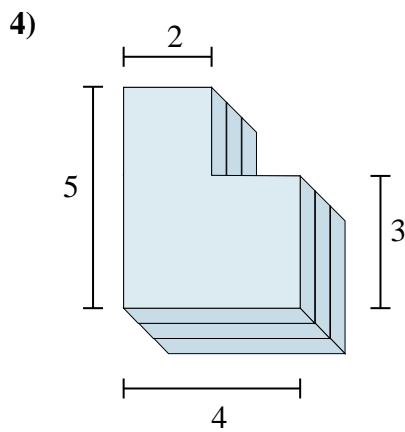
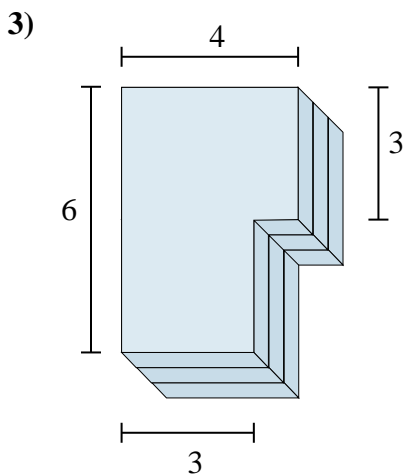
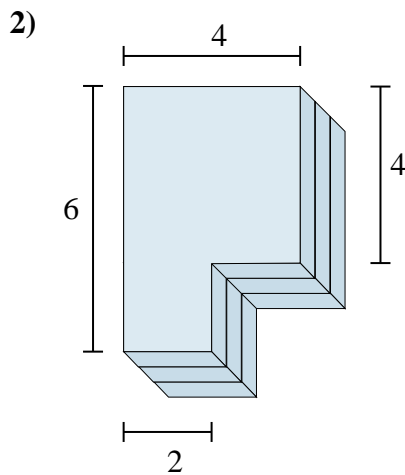
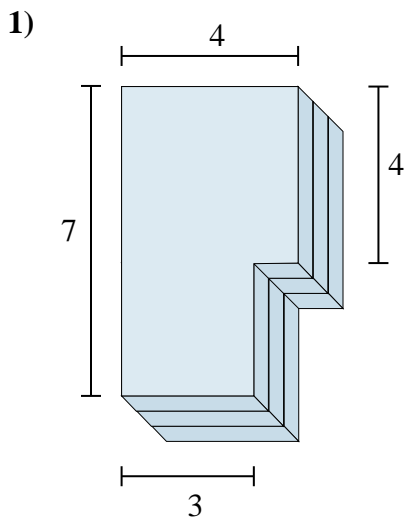

Answers

1. _____

2. _____

3. _____

4. _____

5. _____

6. _____



Find the total volume of each figure shown. Measured in cm (not to scale).

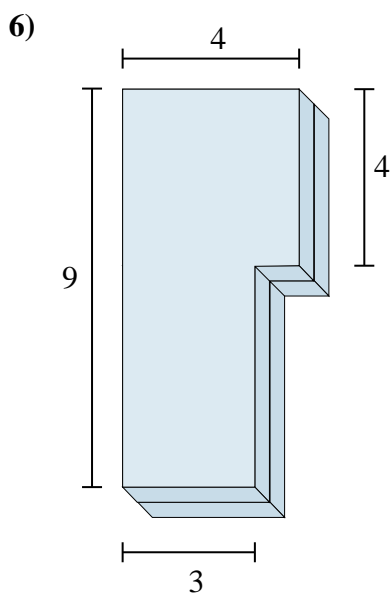
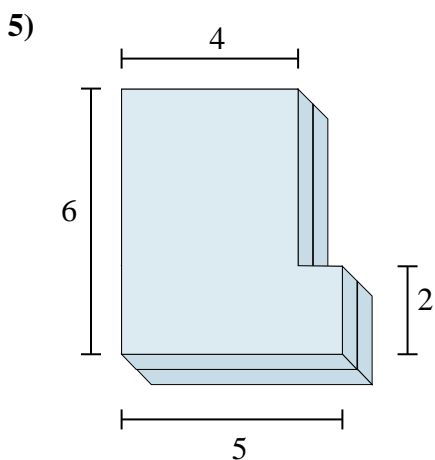
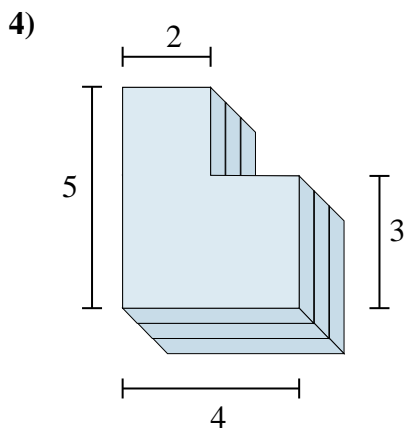
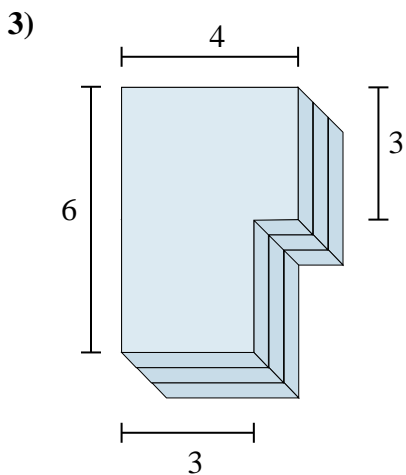
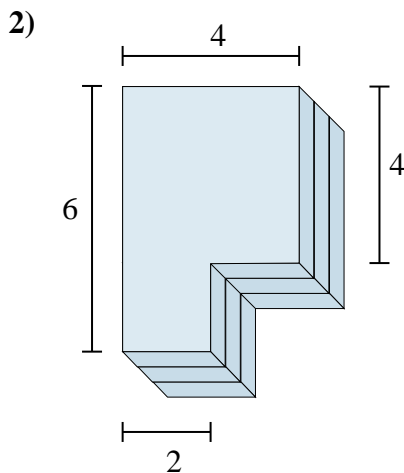
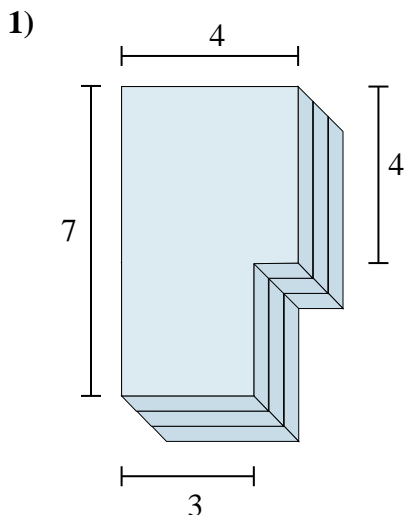

Answers

1. **75 cm³**

2. **60 cm³**

3. **63 cm³**

4. **48 cm³**

5. **52 cm³**

6. **62 cm³**



Find the total volume of each figure shown. Measured in cm (not to scale).

Answers

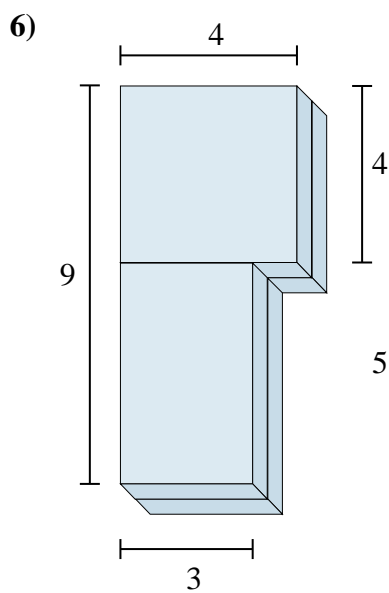
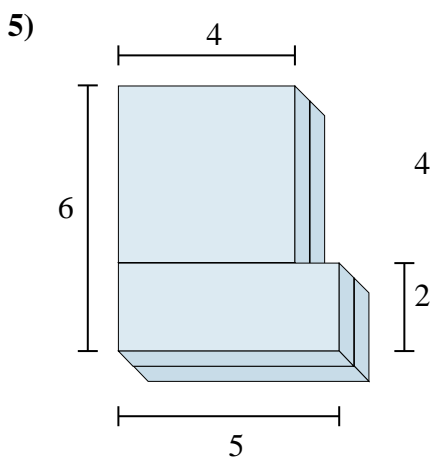
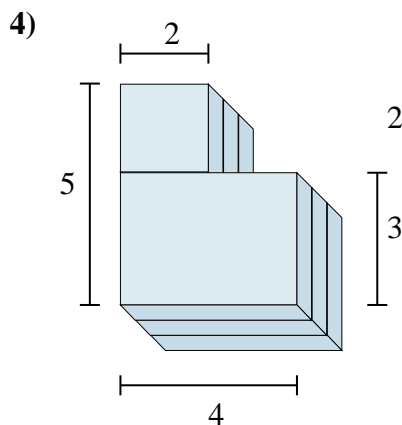
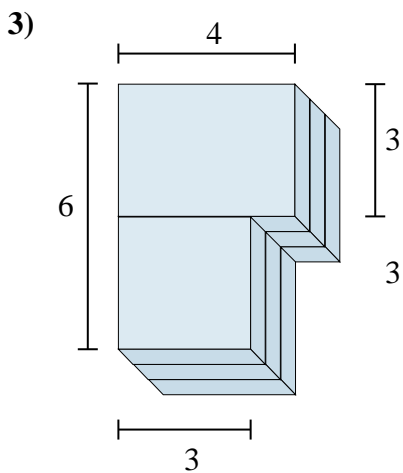
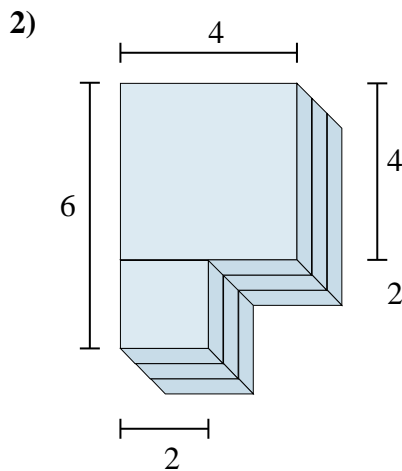
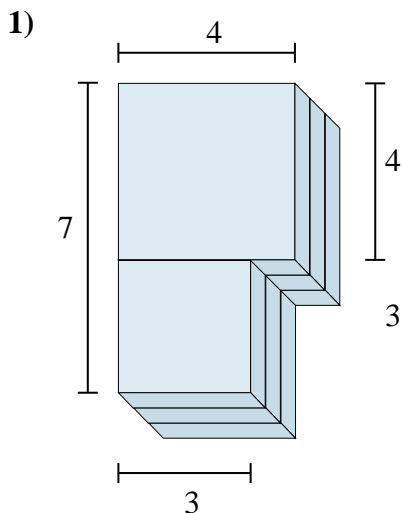

1. _____
2. _____
3. _____
4. _____
5. _____
6. _____