

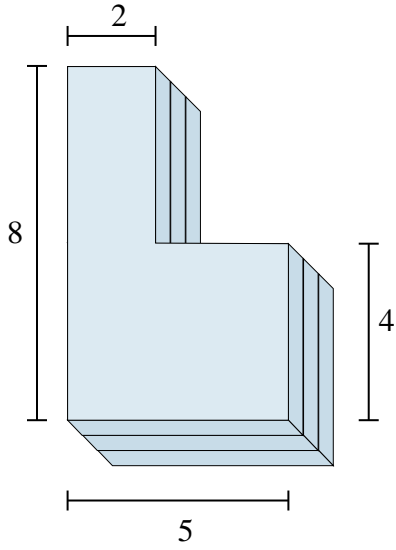

Find the total volume of each figure shown. Measured in cm (not to scale).

Answers

1)



2)

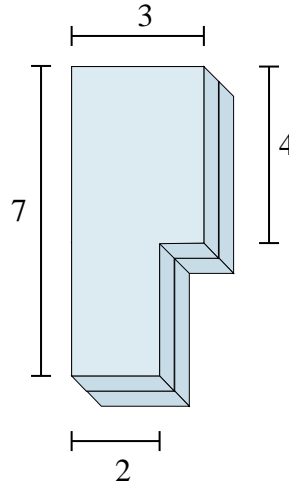

3)

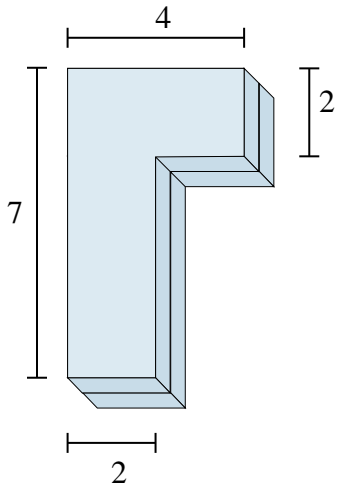

4)

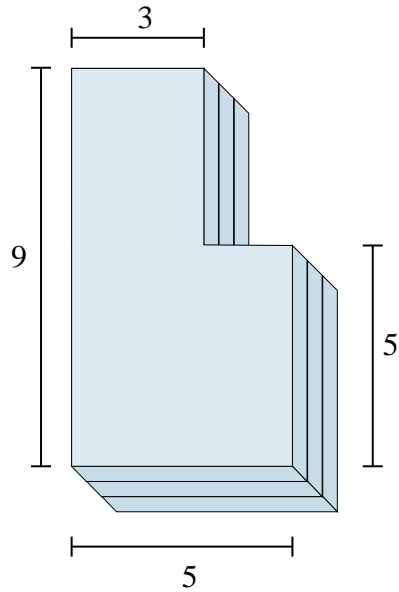

5)

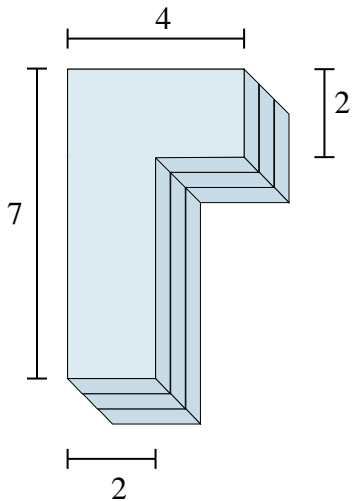

6)

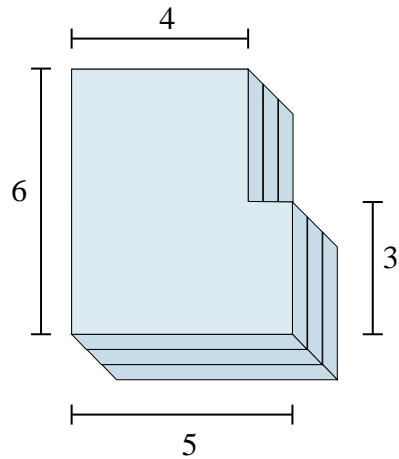

1. _____
2. _____
3. _____
4. _____
5. _____
6. _____



Find the total volume of each figure shown. Measured in cm (not to scale).

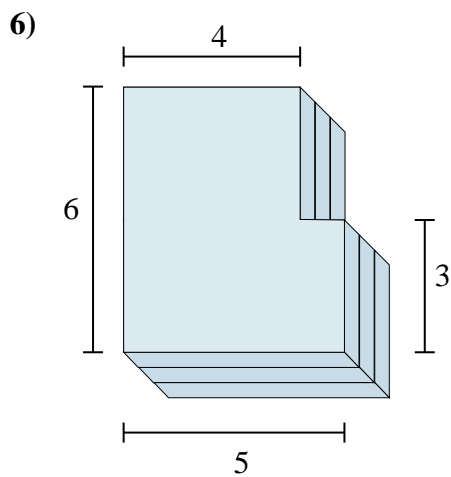
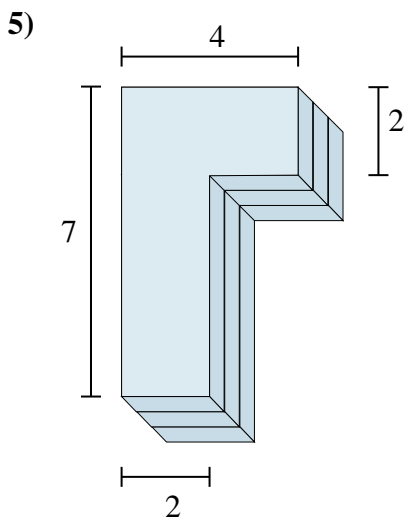
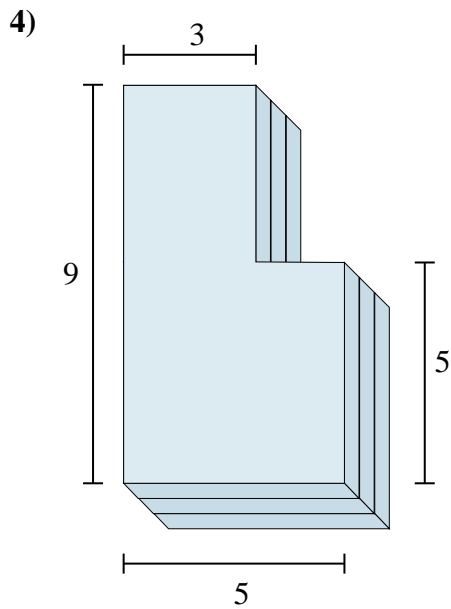
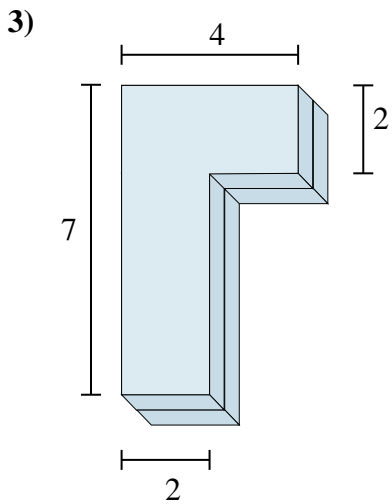
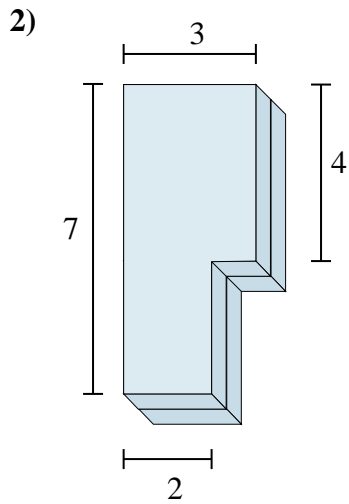
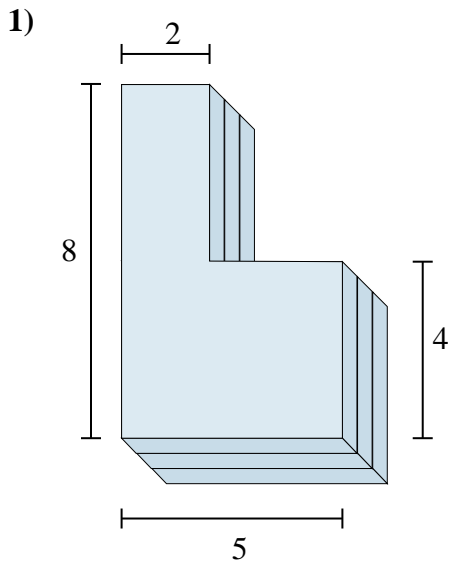

Answers

1. 84 cm³

2. 36 cm³

3. 36 cm³

4. 111 cm³

5. 54 cm³

6. 81 cm³



Find the total volume of each figure shown. Measured in cm (not to scale).

Answers

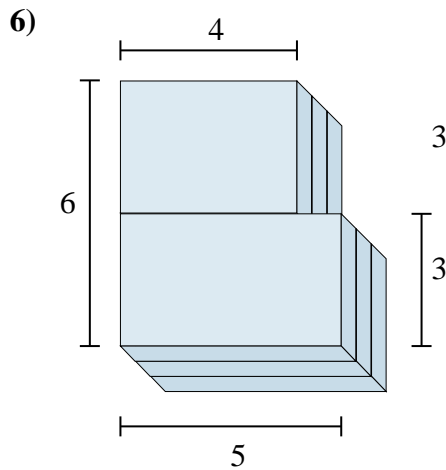
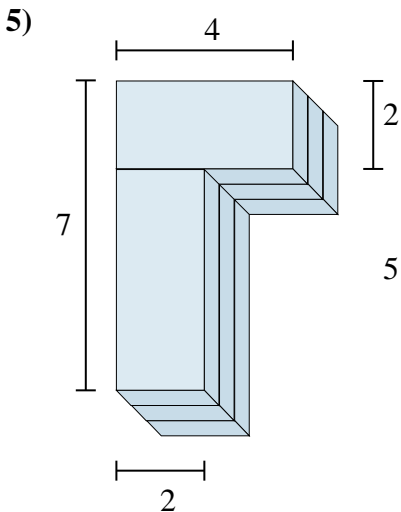
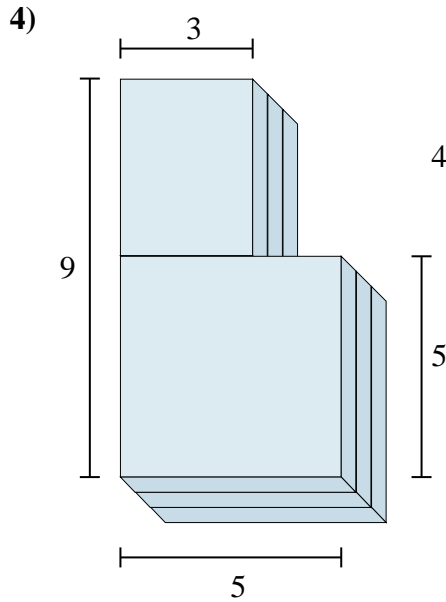
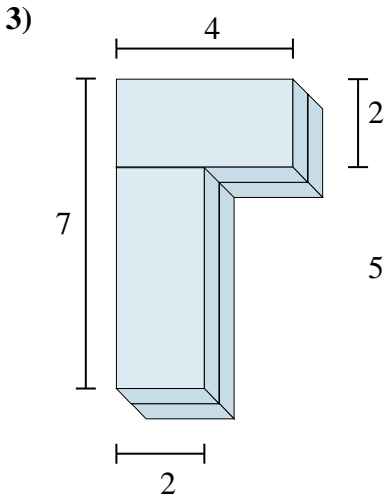
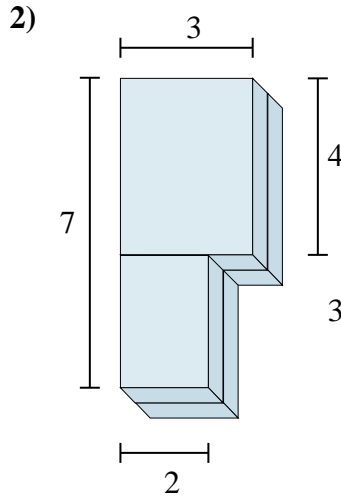
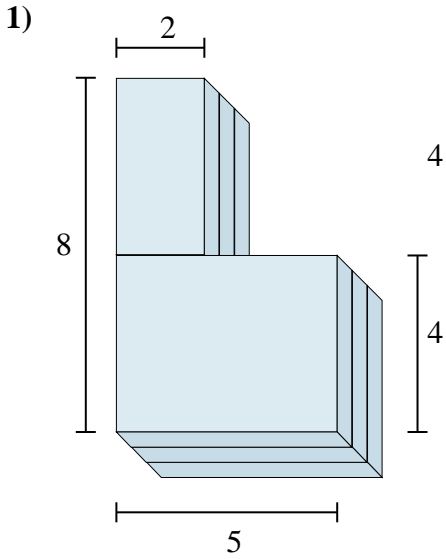

1. _____
2. _____
3. _____
4. _____
5. _____
6. _____