

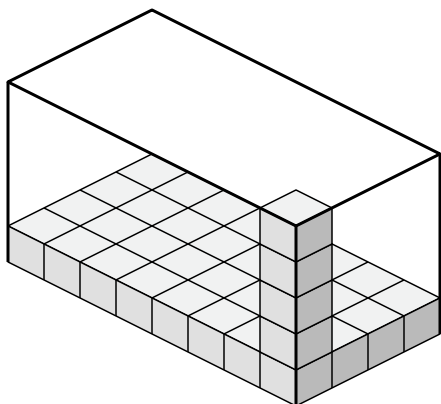

Create an expression to determine the volume of each box.

Answers

1)



2)

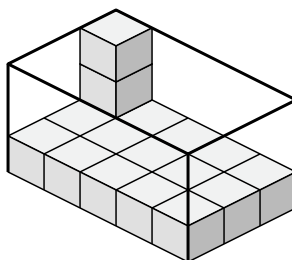

3)

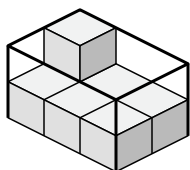

4)

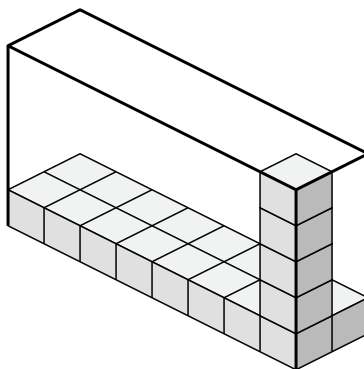

5)

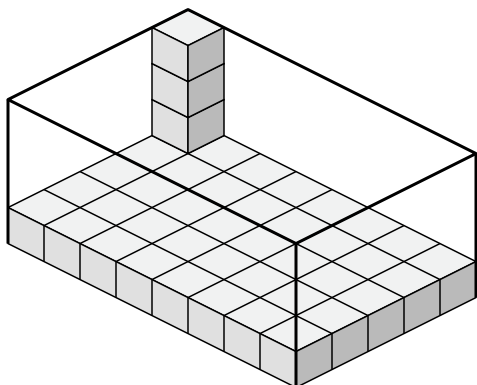

6)

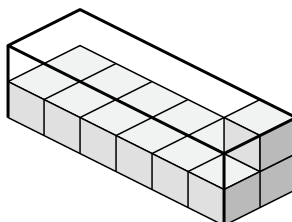

7)

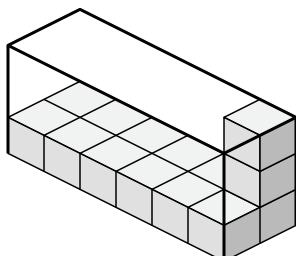

8)

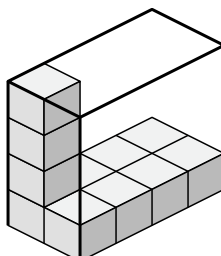

- 1. _____
- 2. _____
- 3. _____
- 4. _____
- 5. _____
- 6. _____
- 7. _____
- 8. _____



Create an expression to determine the volume of each box.

1)

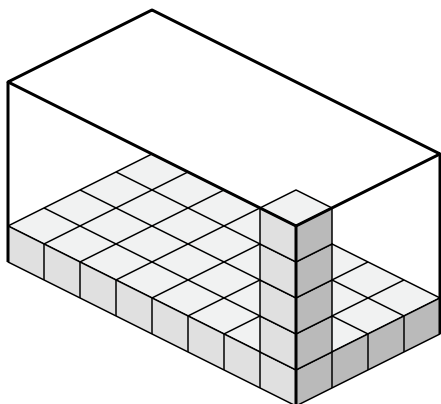

2)

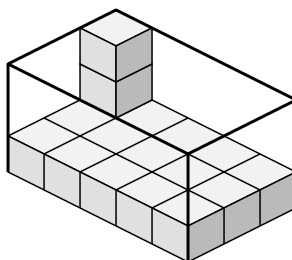

3)

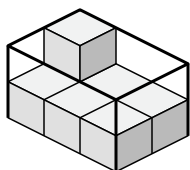

4)

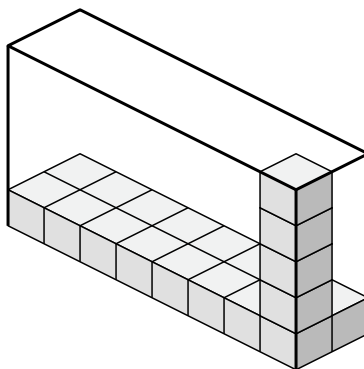

5)

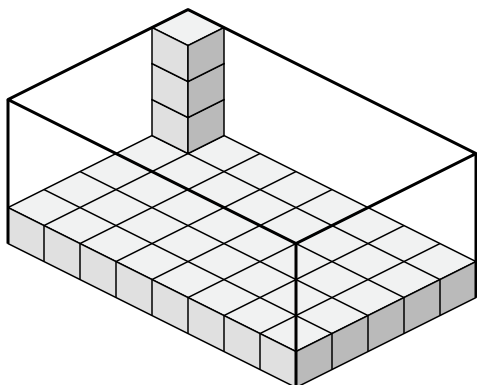

6)

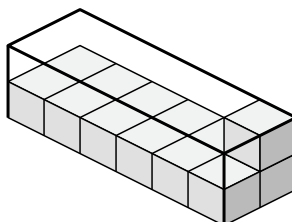

7)

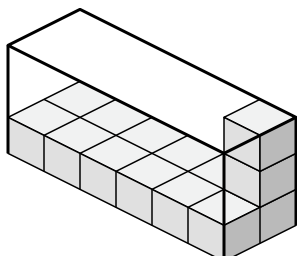

8)

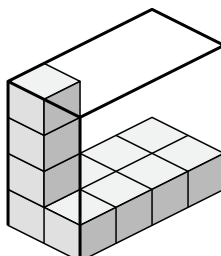

Answers

1. 8×4×5

2. 5×3×3

3. 3×2×2

4. 8×2×5

5. 8×5×4

6. 6×2×2

7. 6×2×3

8. 2×4×4