

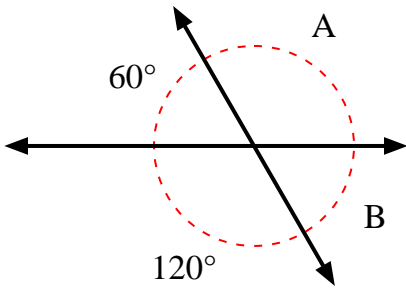

Find the value of angle 'A' and angle 'B'.

1)



2)

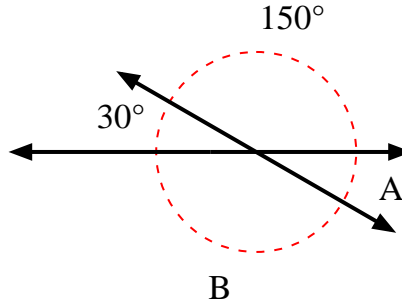

3)

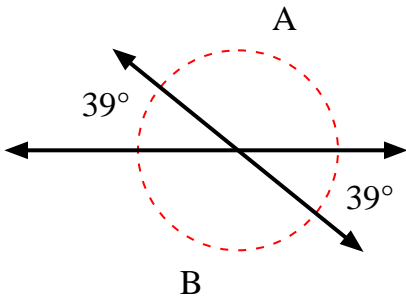

4)

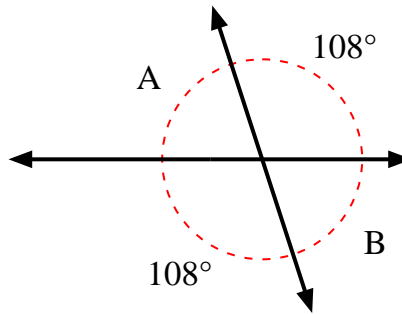

5)

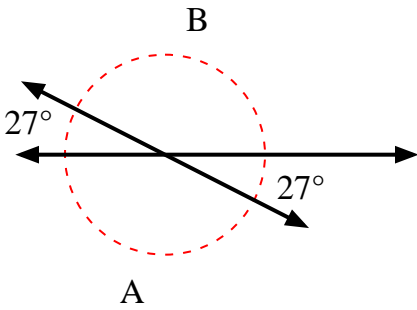

6)

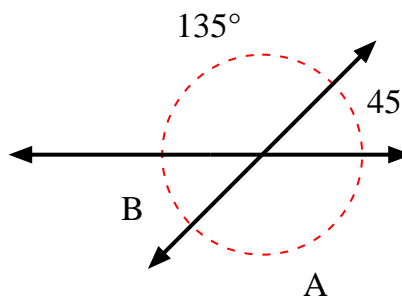

7)

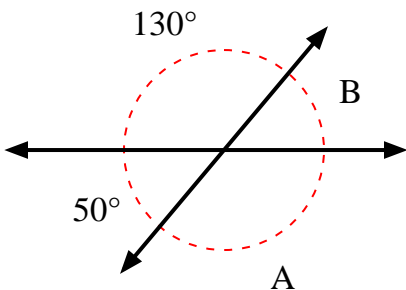

8)

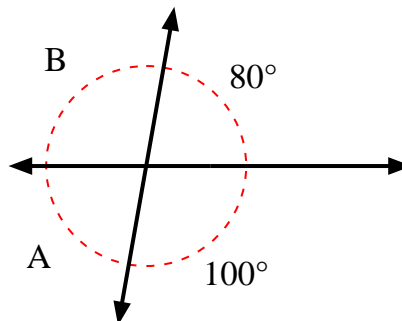

Answers

1. _____
2. _____
3. _____
4. _____
5. _____
6. _____
7. _____
8. _____



Find the value of angle 'A' and angle 'B'.

1)

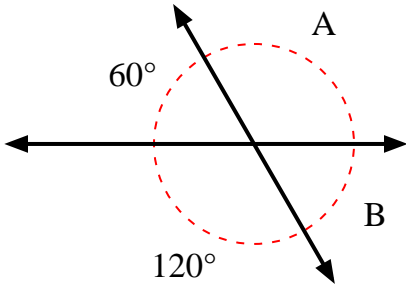

2)

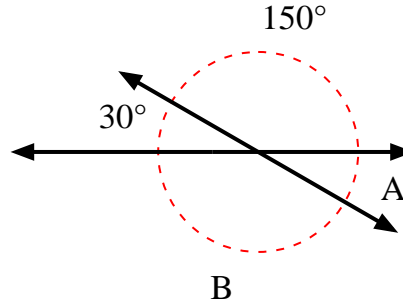

3)

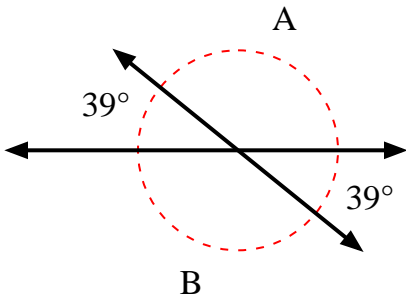

4)

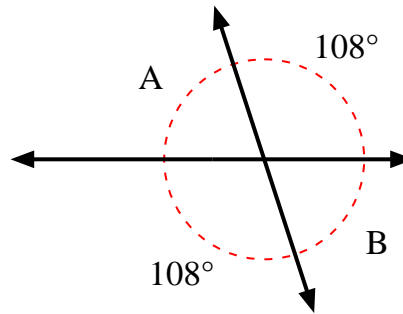

5)

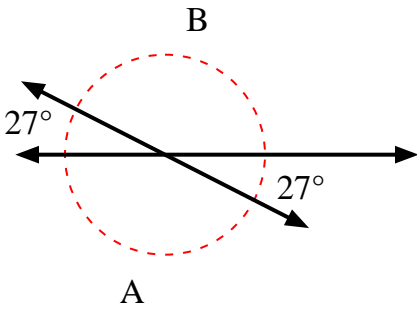

6)

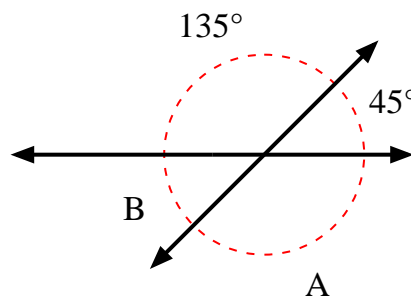

7)

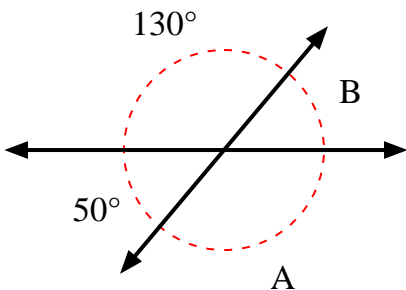

8)

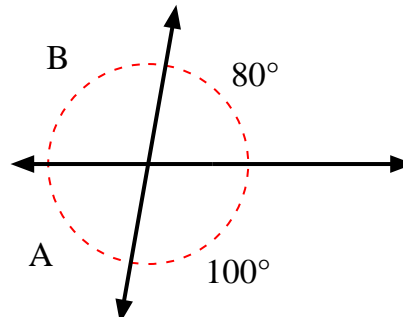

Answers

- | | | |
|----|-------------|-------------|
| 1. | 120° | 60° |
| 2. | 30° | 150° |
| 3. | 141° | 141° |
| 4. | 72° | 72° |
| 5. | 153° | 153° |
| 6. | 135° | 45° |
| 7. | 130° | 50° |
| 8. | 80° | 100° |



Find the value of angle 'A' and angle 'B'.

1)

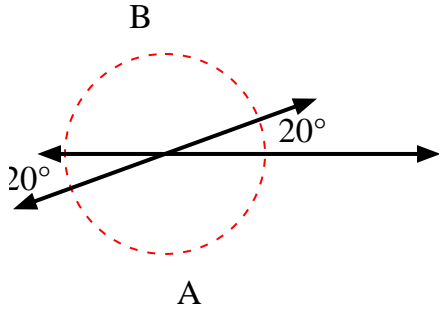

2)

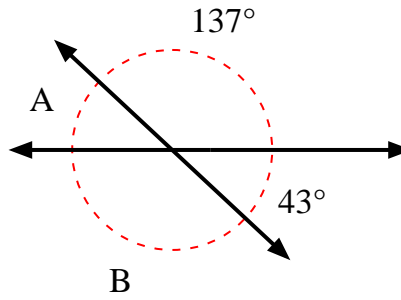

3)

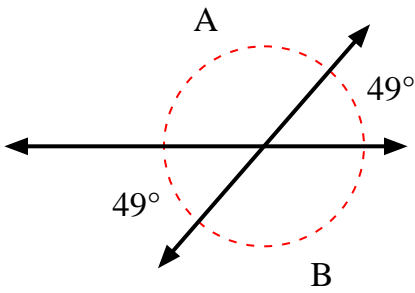

4)

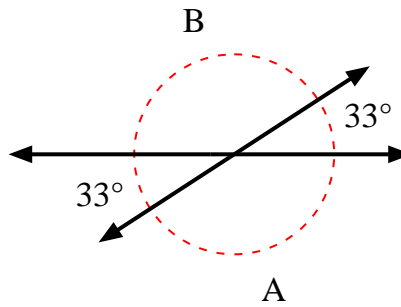

5)

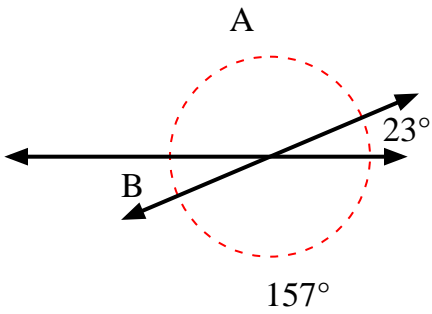

6)

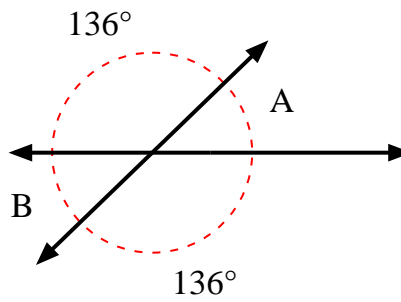

7)

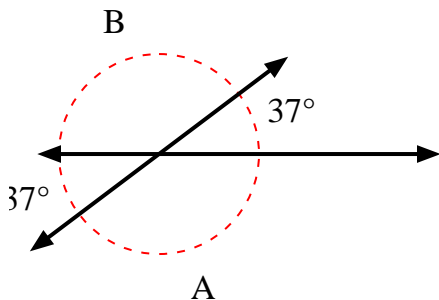

8)

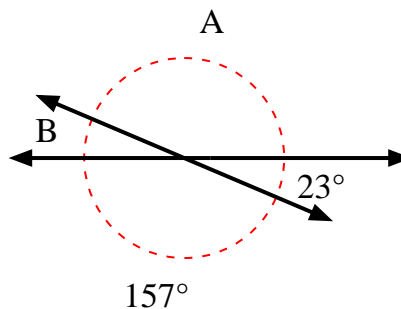

Answers

1. _____
2. _____
3. _____
4. _____
5. _____
6. _____
7. _____
8. _____



Find the value of angle 'A' and angle 'B'.

1)

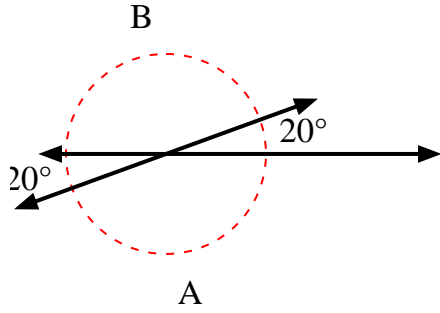

2)

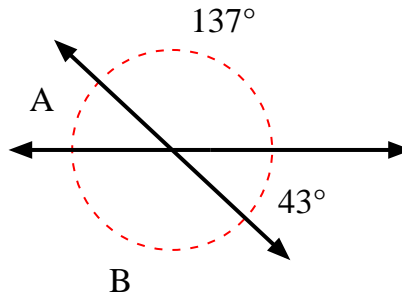

3)

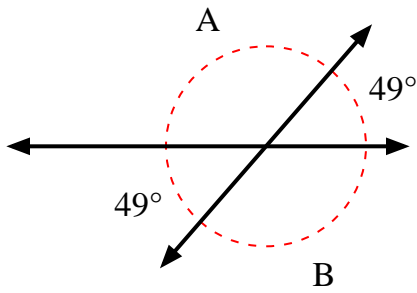

4)

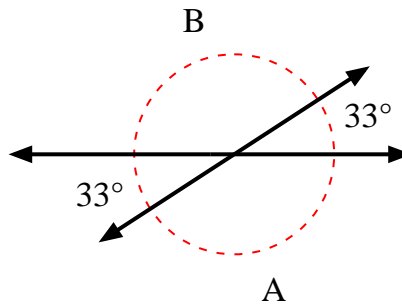

5)

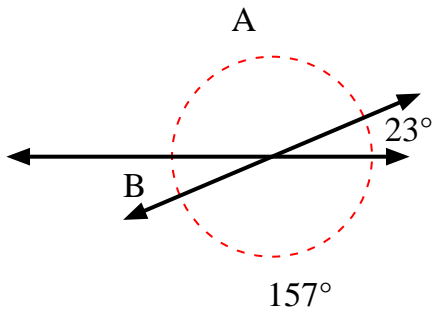

6)

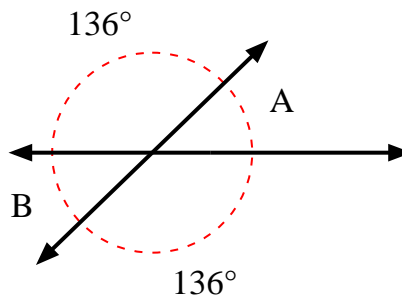

7)

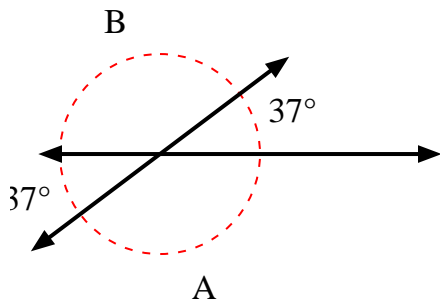

8)

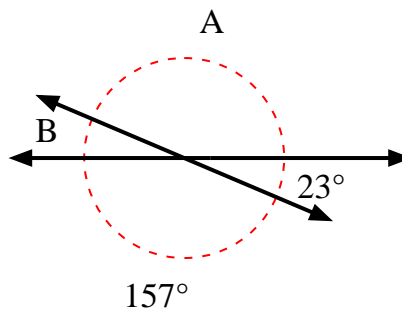

Answers

1.	160°	160°
2.	43°	137°
3.	131°	131°
4.	147°	147°
5.	157°	23°
6.	44°	44°
7.	143°	143°
8.	157°	23°



Find the value of angle 'A' and angle 'B'.

1)

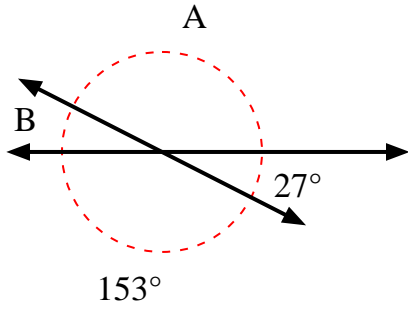

2)

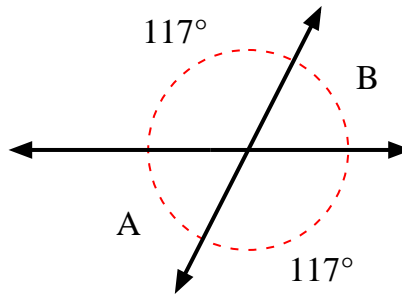

3)

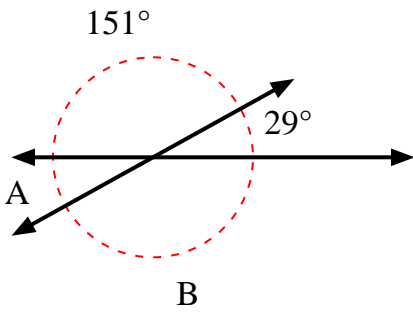

4)

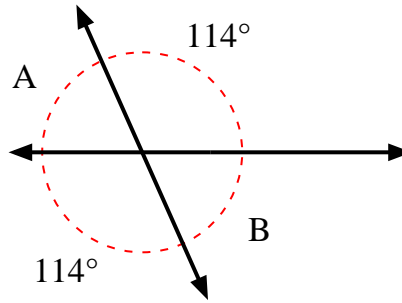

5)

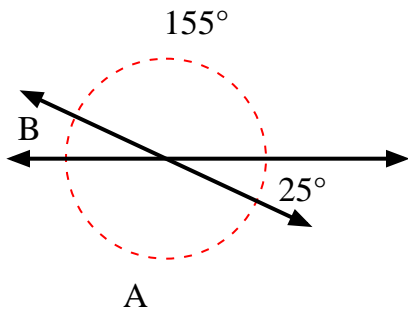

6)

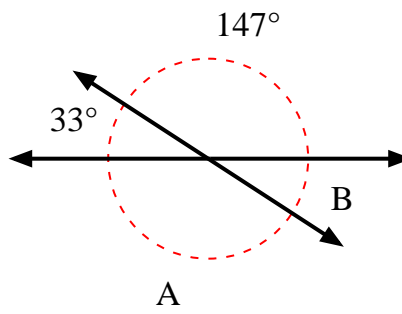

7)

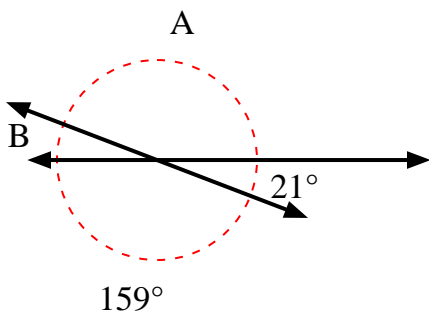

8)

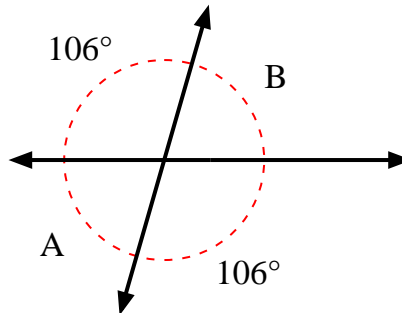

Answers

1. _____
2. _____
3. _____
4. _____
5. _____
6. _____
7. _____
8. _____



Find the value of angle 'A' and angle 'B'.

1)

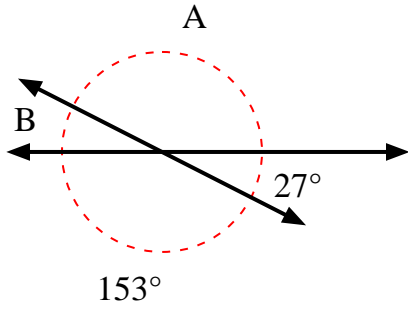

2)

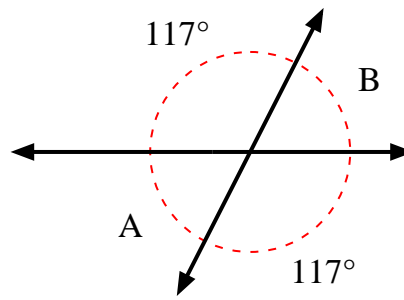

3)

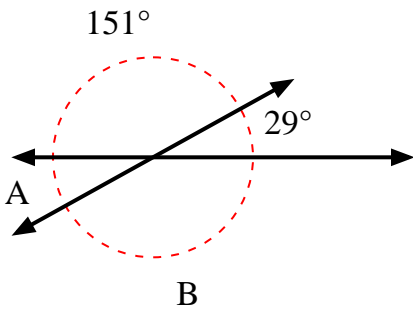

4)

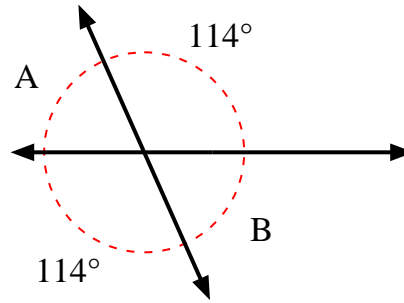

5)

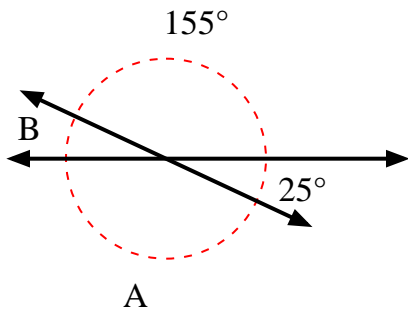

6)

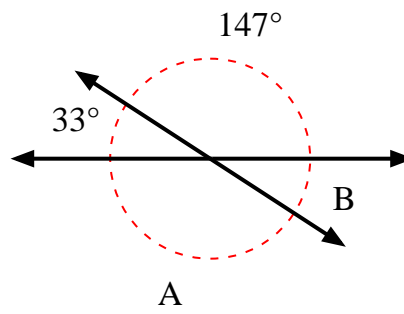

7)

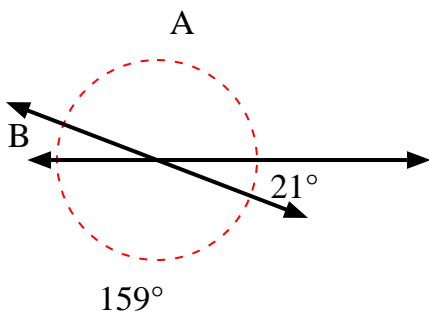

8)

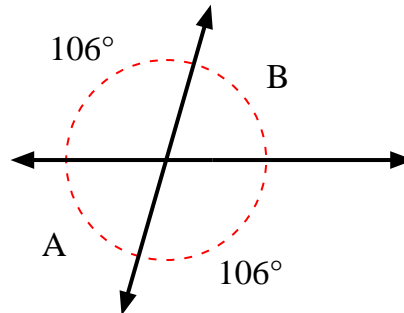

Answers

1.	153°	27°
2.	63°	63°
3.	29°	151°
4.	66°	66°
5.	155°	25°
6.	147°	33°
7.	159°	21°
8.	74°	74°



Find the value of angle 'A' and angle 'B'.

1)

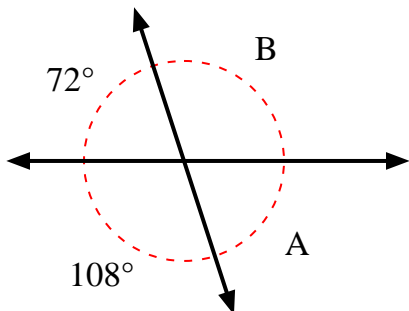

2)

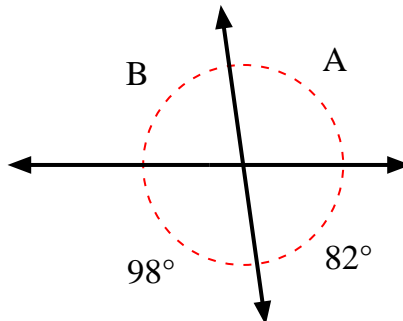

3)

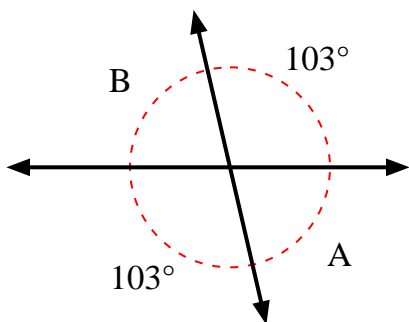

4)

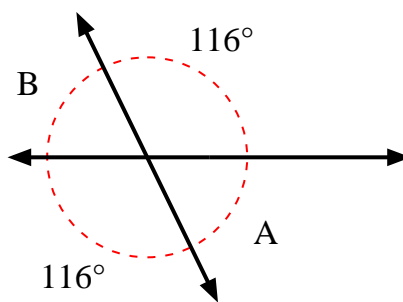

5)

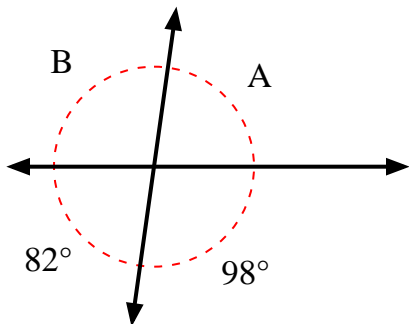

6)

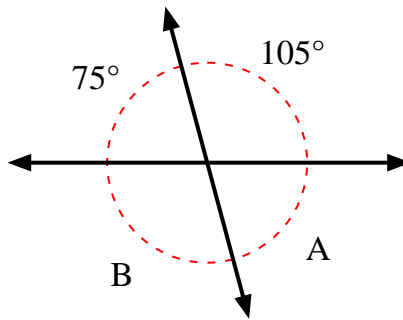

7)

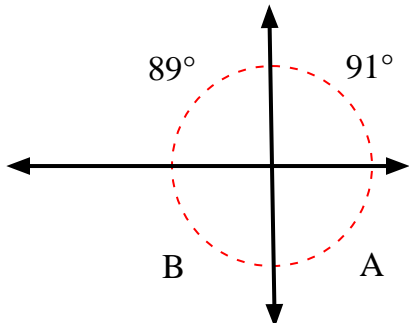

8)

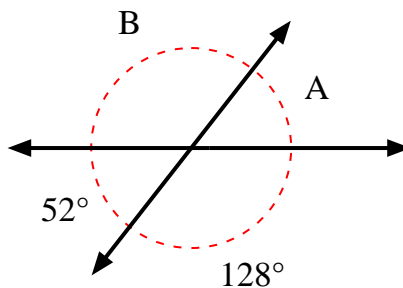

Answers

1. _____
2. _____
3. _____
4. _____
5. _____
6. _____
7. _____
8. _____



Find the value of angle 'A' and angle 'B'.

1)

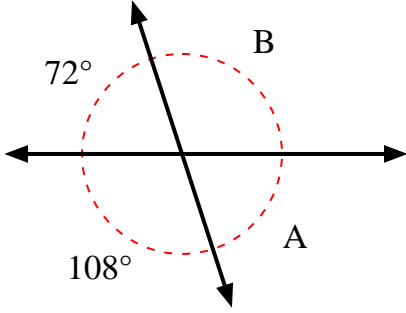

2)

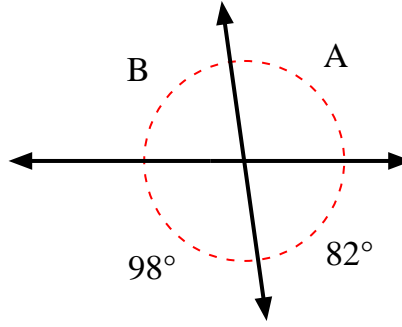

3)

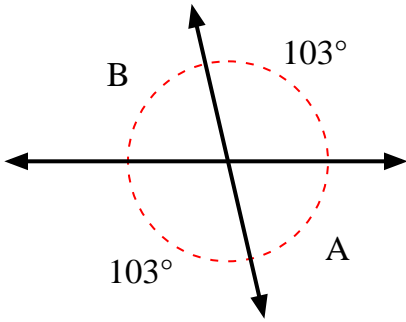

4)

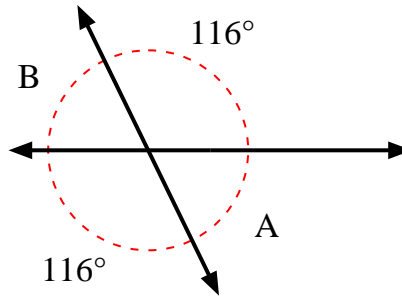

5)

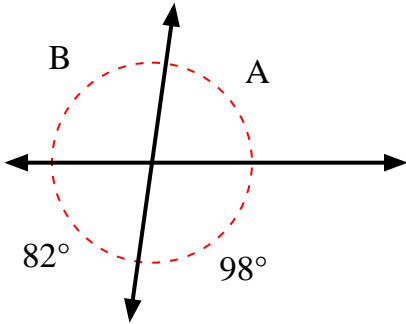

6)

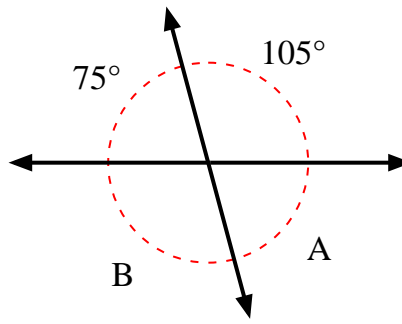

7)

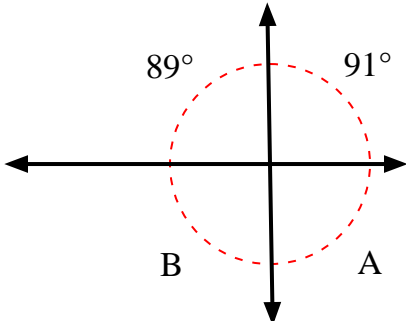

8)

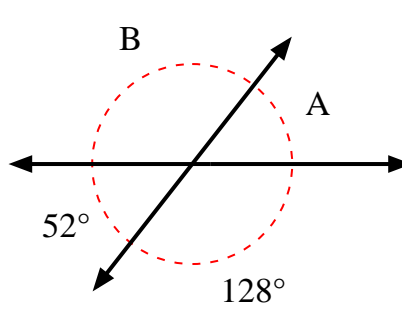

Answers

1.	72°	108°
2.	98°	82°
3.	77°	77°
4.	64°	64°
5.	82°	98°
6.	75°	105°
7.	89°	91°
8.	52°	128°



Find the value of angle 'A' and angle 'B'.

1)

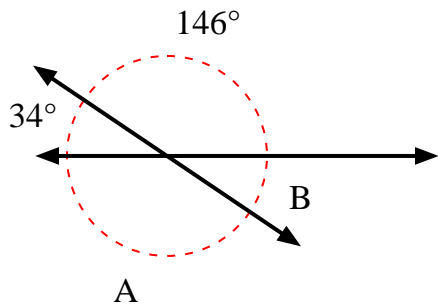

2)

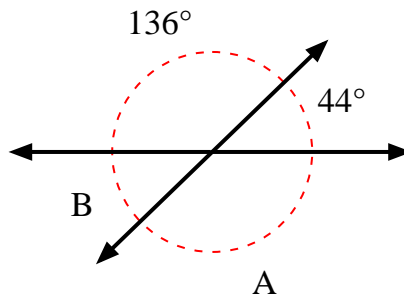

3)

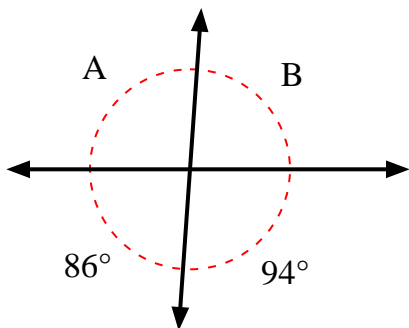

4)

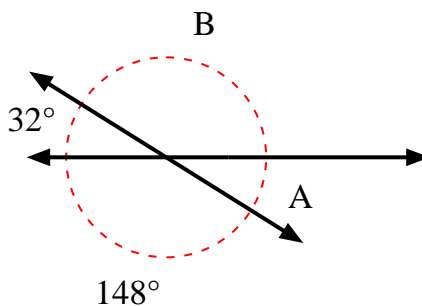

5)

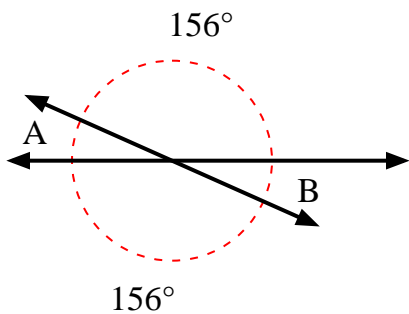

6)

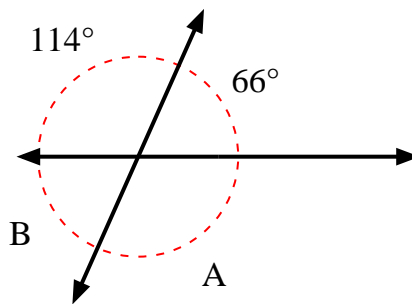

7)

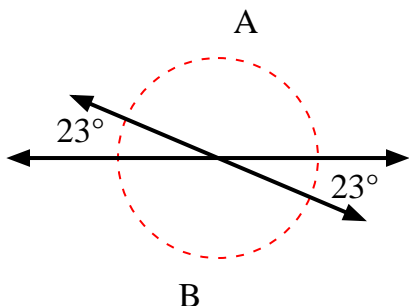

8)

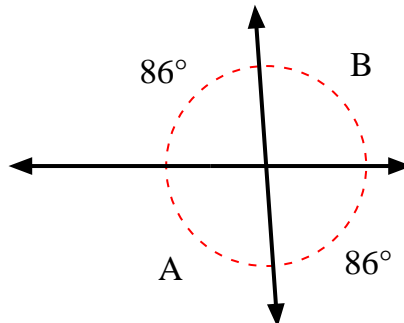

Answers

1. _____
2. _____
3. _____
4. _____
5. _____
6. _____
7. _____
8. _____



Find the value of angle 'A' and angle 'B'.

1)

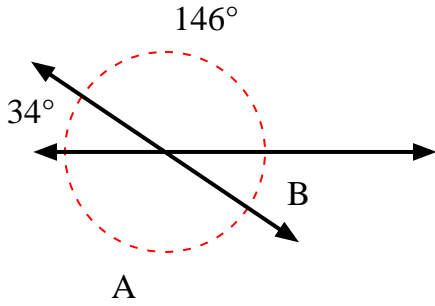

2)

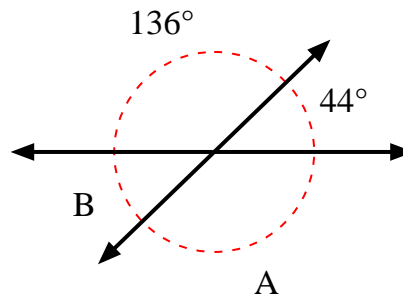

3)

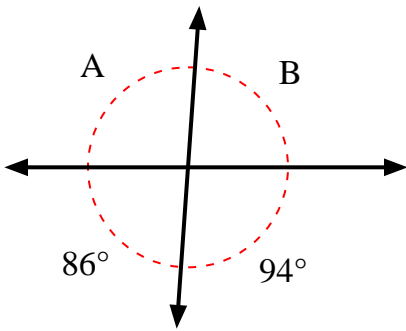

4)

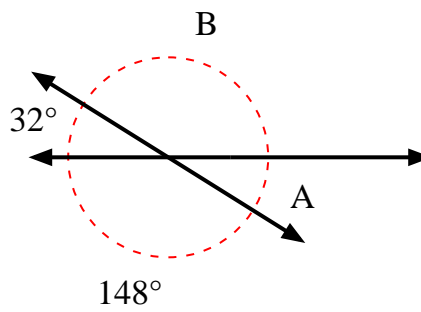

5)

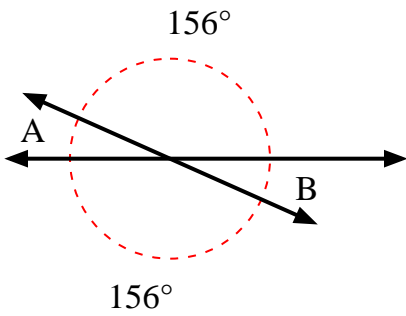

6)

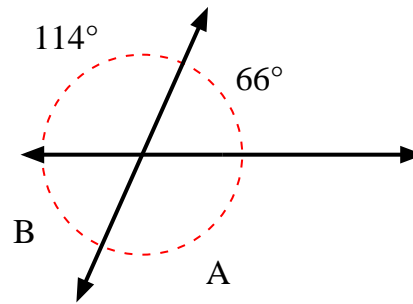

7)

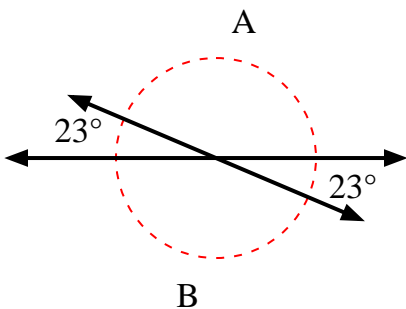

8)

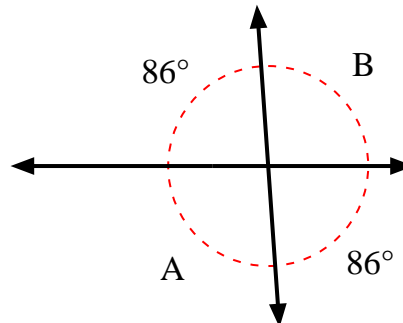

Answers

- | | | |
|----|-------------|-------------|
| 1. | 146° | 34° |
| 2. | 136° | 44° |
| 3. | 94° | 86° |
| 4. | 32° | 148° |
| 5. | 24° | 24° |
| 6. | 114° | 66° |
| 7. | 157° | 157° |
| 8. | 94° | 94° |



Find the value of angle 'A' and angle 'B'.

1)

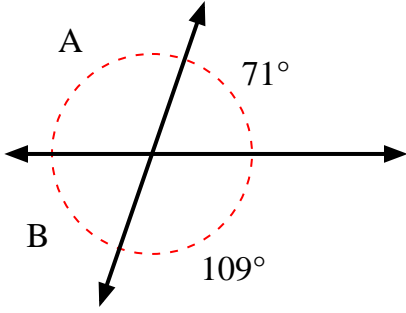

2)

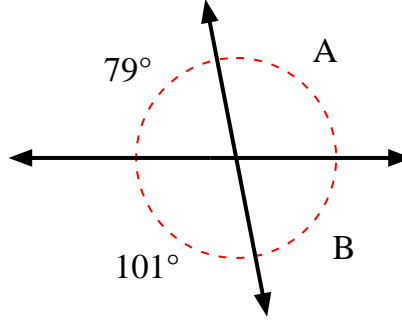

3)

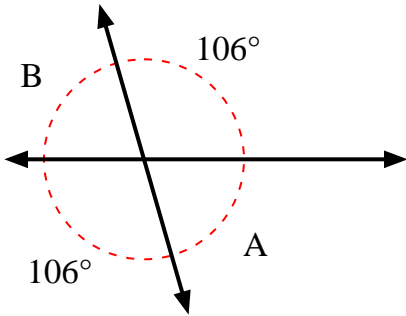

4)

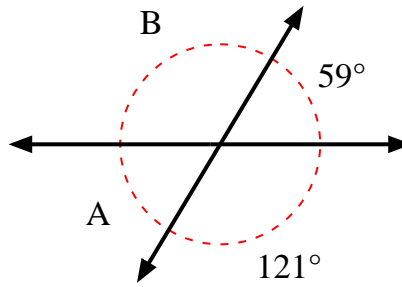

5)

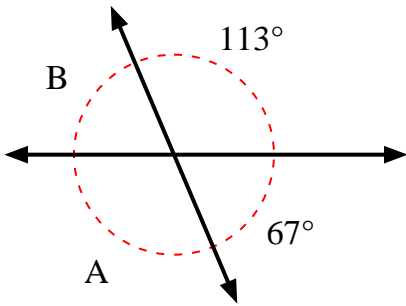

6)

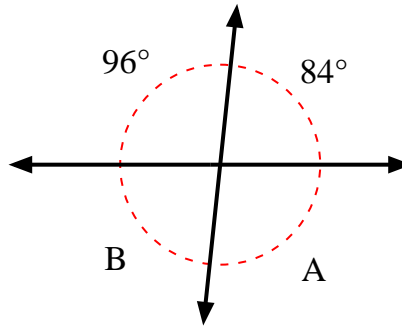

7)

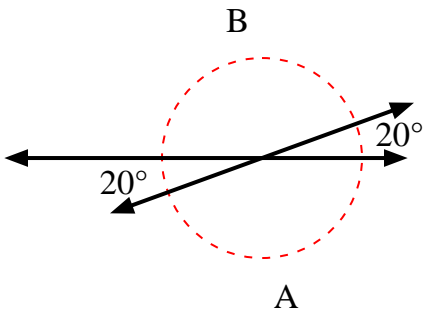

8)

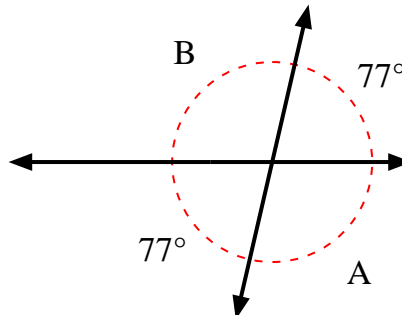

Answers

1. _____
2. _____
3. _____
4. _____
5. _____
6. _____
7. _____
8. _____



Find the value of angle 'A' and angle 'B'.

1)

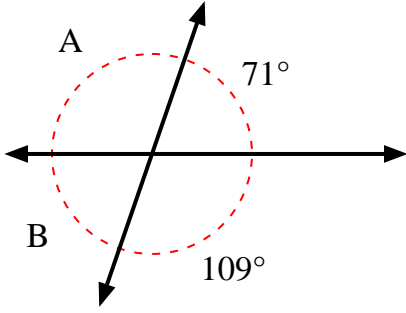

2)

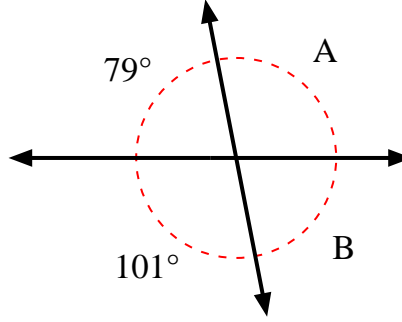

3)

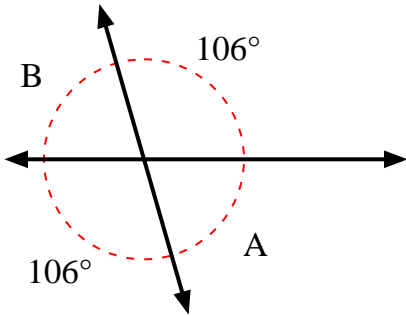

4)

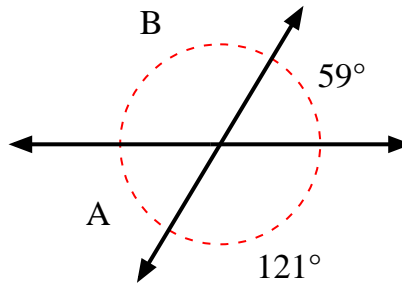

5)

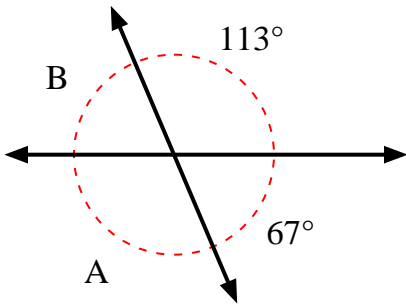

6)

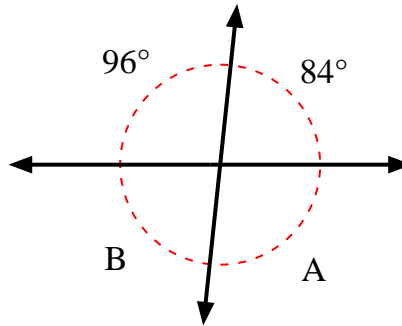

7)

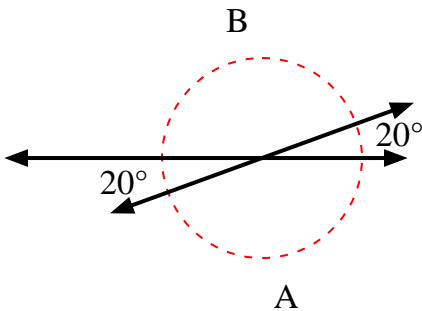

8)

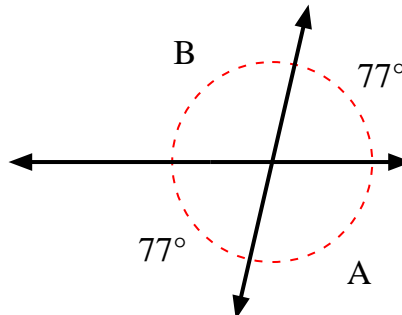

Answers

1.	109°	71°
2.	101°	79°
3.	74°	74°
4.	59°	121°
5.	113°	67°
6.	96°	84°
7.	160°	160°
8.	103°	103°



Find the value of angle 'A' and angle 'B'.

1)

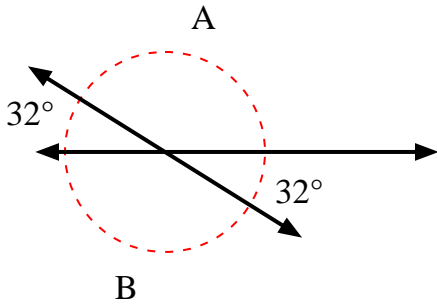

2)

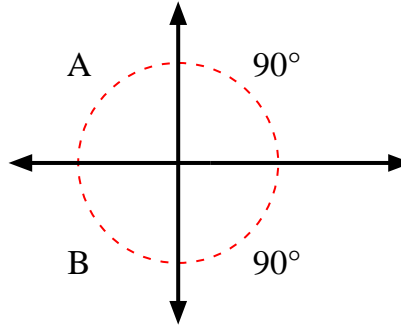

3)

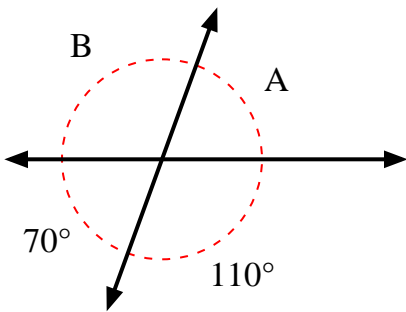

4)

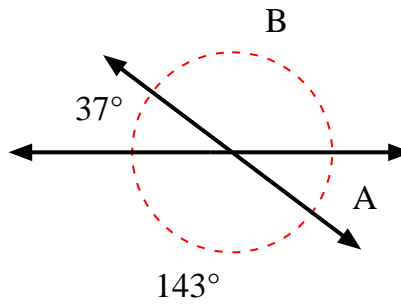

5)

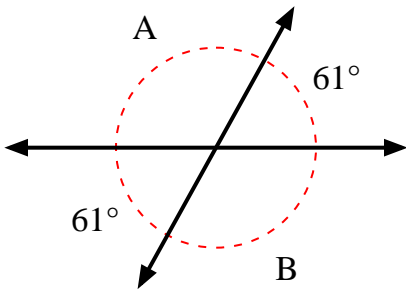

6)

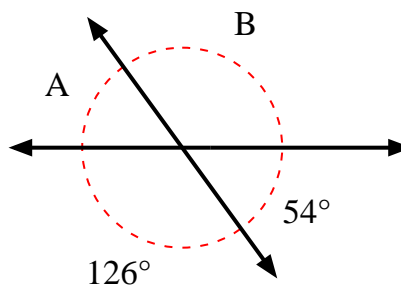

7)

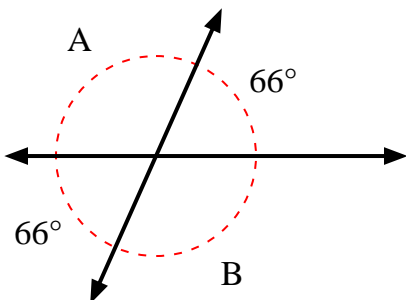

8)

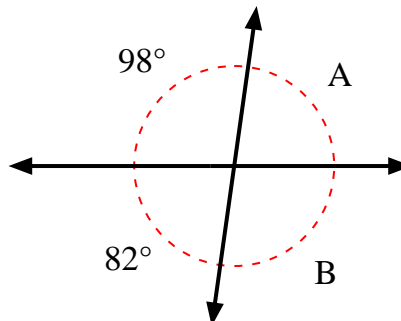

Answers

1. _____
2. _____
3. _____
4. _____
5. _____
6. _____
7. _____
8. _____



Find the value of angle 'A' and angle 'B'.

1)

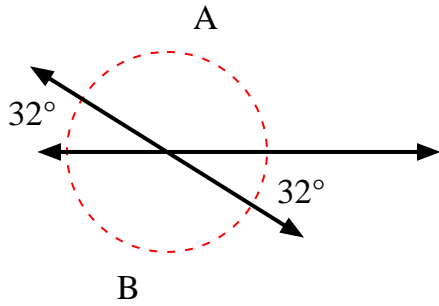

2)

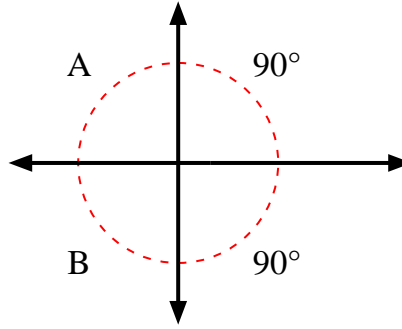

3)

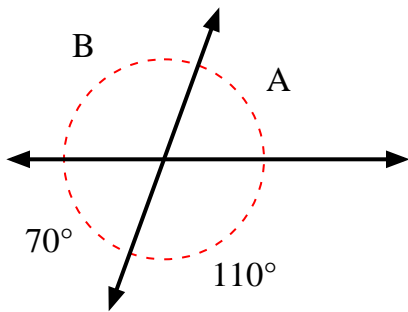

4)

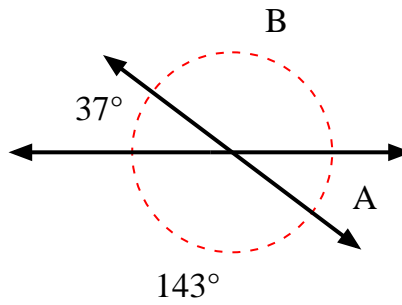

5)

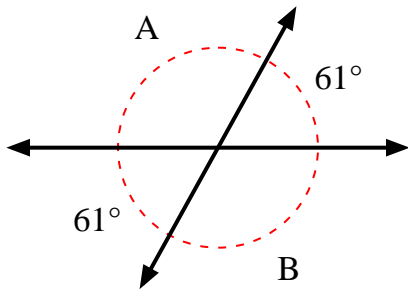

6)

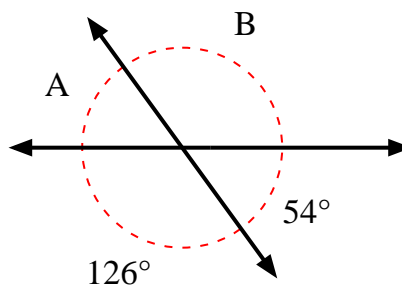

7)

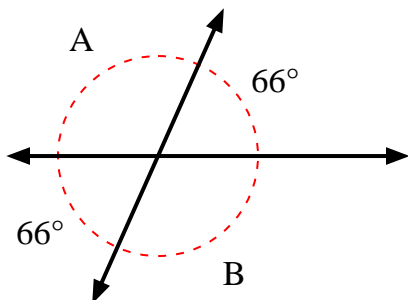

8)

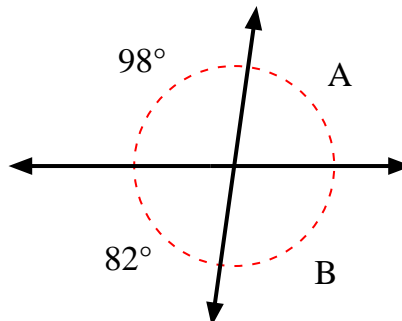

Answers

1.	148°	148°
2.	90°	90°
3.	70°	110°
4.	37°	143°
5.	119°	119°
6.	54°	126°
7.	114°	114°
8.	82°	98°



Find the value of angle 'A' and angle 'B'.

1)

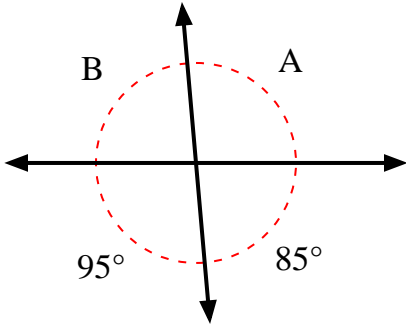

2)

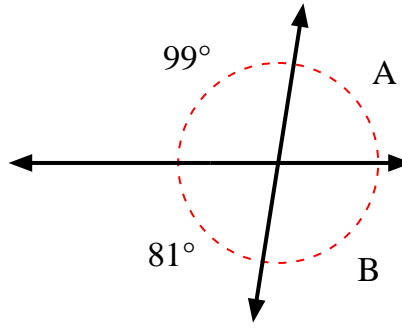

3)

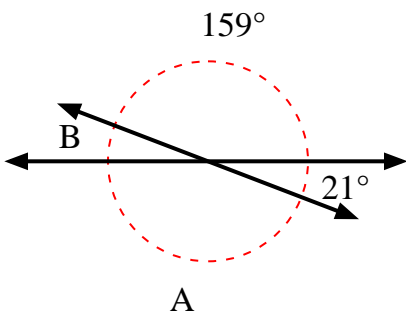

4)

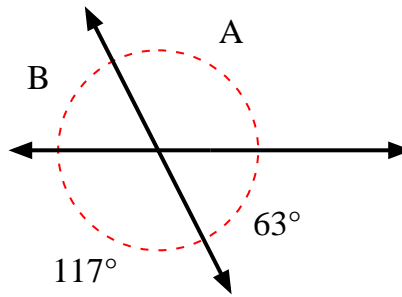

5)

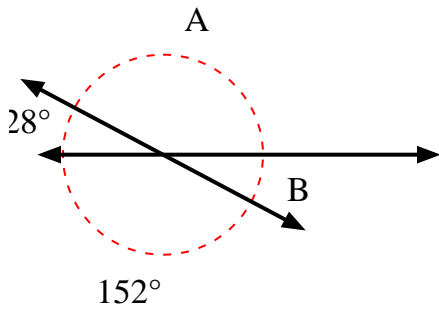

6)

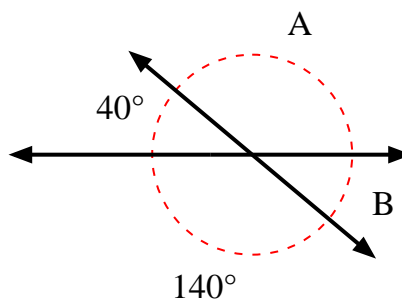

7)

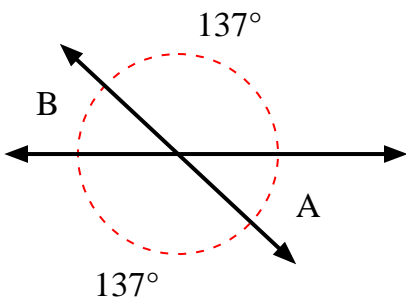

8)

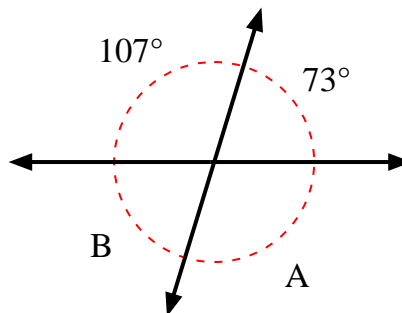

Answers

1. _____
2. _____
3. _____
4. _____
5. _____
6. _____
7. _____
8. _____



Find the value of angle 'A' and angle 'B'.

1)

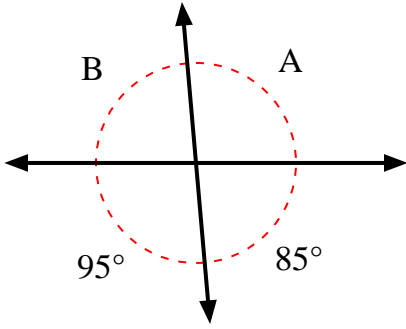

2)

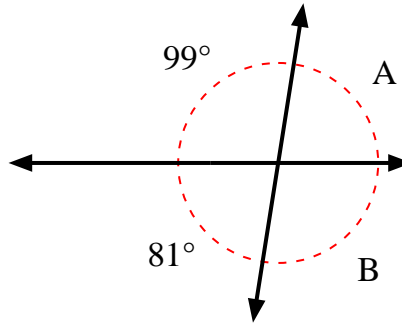

3)

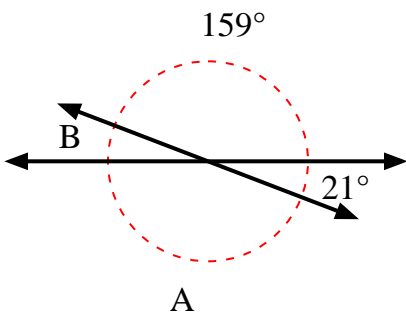

4)

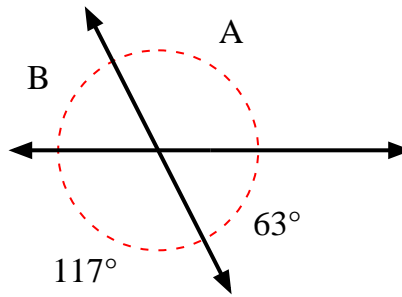

5)

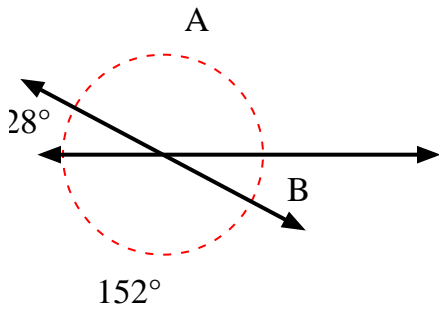

6)

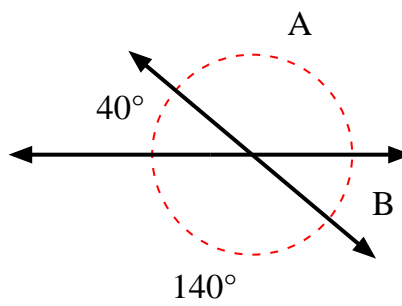

7)

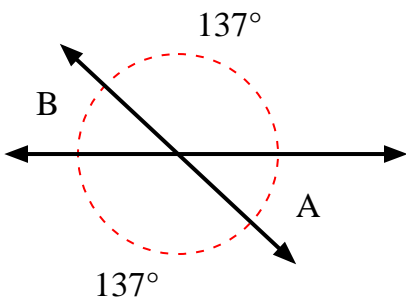

8)

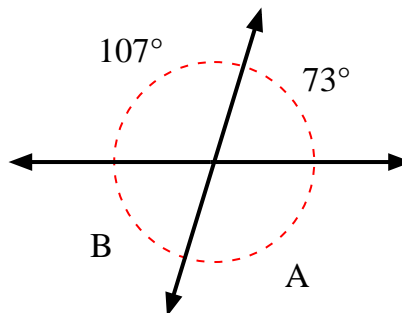

Answers

1.	95°	85°
2.	81°	99°
3.	159°	21°
4.	117°	63°
5.	152°	28°
6.	140°	40°
7.	43°	43°
8.	107°	73°



Find the value of angle 'A' and angle 'B'.

1)

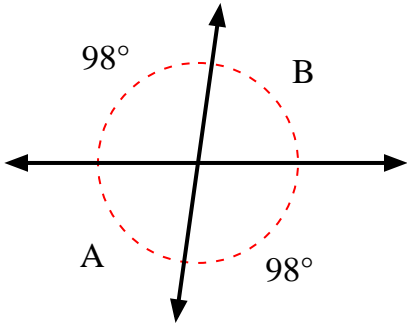

2)

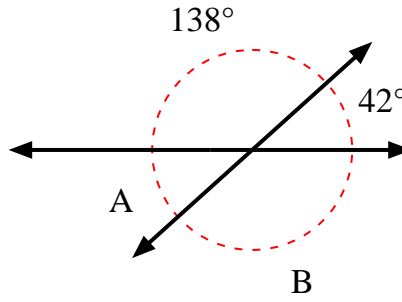

3)

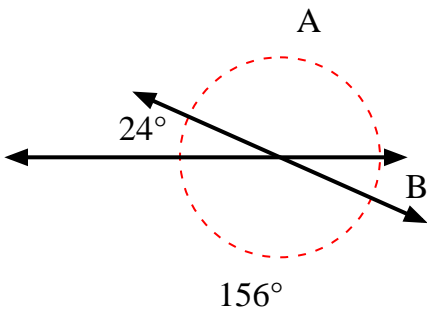

4)

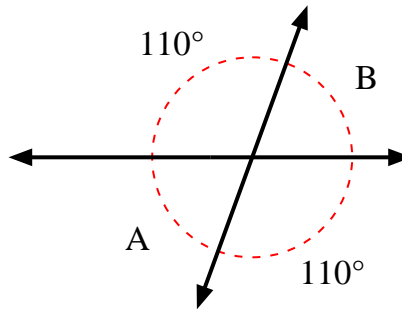

5)

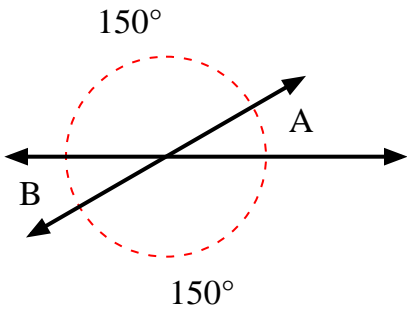

6)

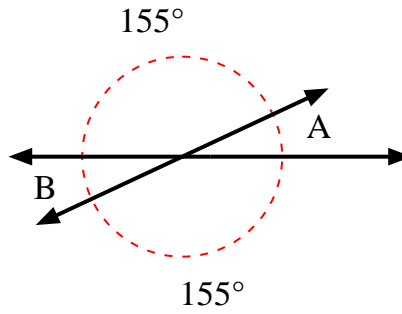

7)

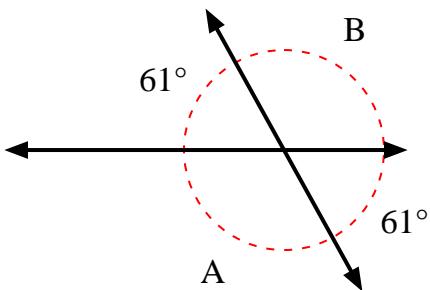

8)

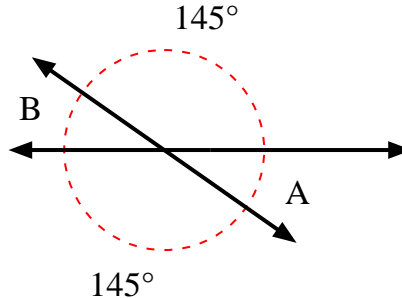

Answers

1. _____
2. _____
3. _____
4. _____
5. _____
6. _____
7. _____
8. _____



Find the value of angle 'A' and angle 'B'.

1)

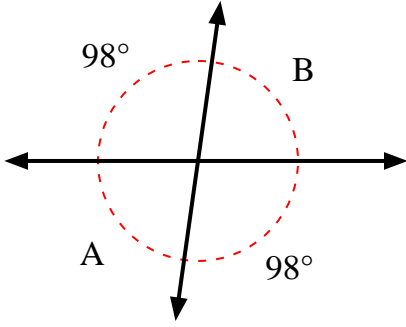

2)

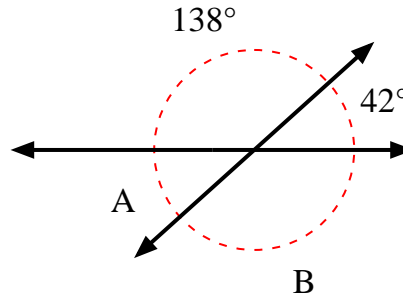

3)

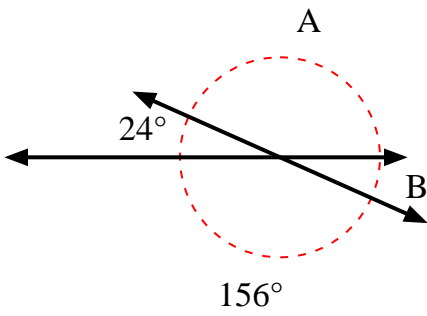

4)

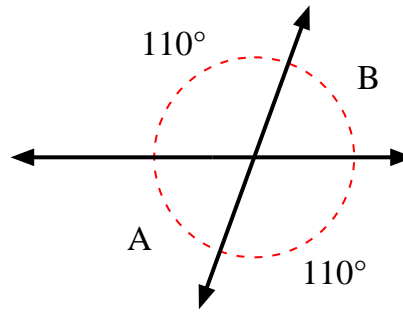

5)

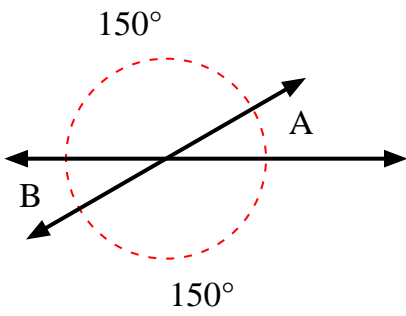

6)

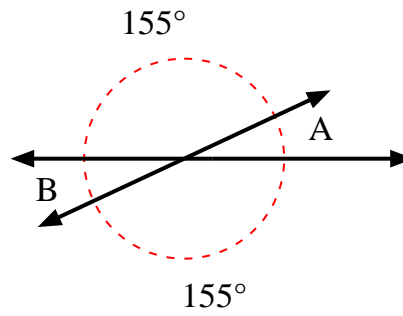

7)

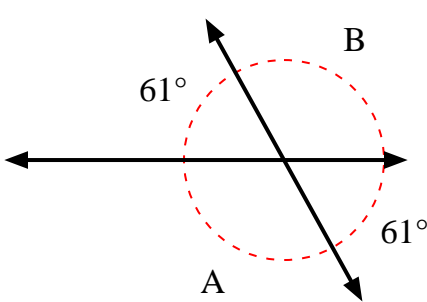

8)

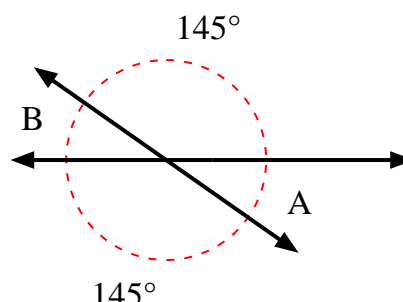

Answers

1.	82°	82°
2.	42°	138°
3.	156°	24°
4.	70°	70°
5.	30°	30°
6.	25°	25°
7.	119°	119°
8.	35°	35°



Find the value of angle 'A' and angle 'B'.

1)

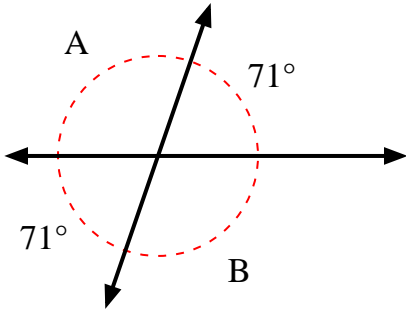

2)

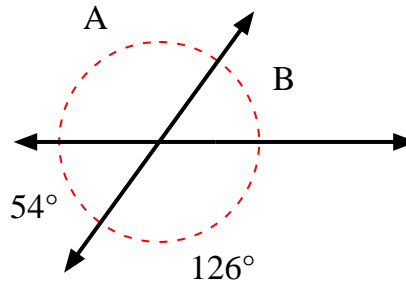

3)

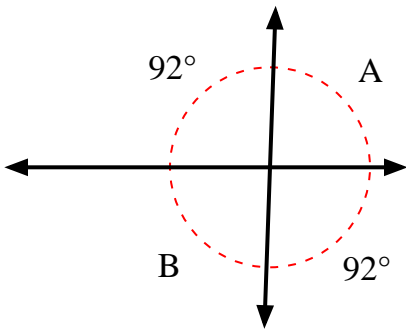

4)

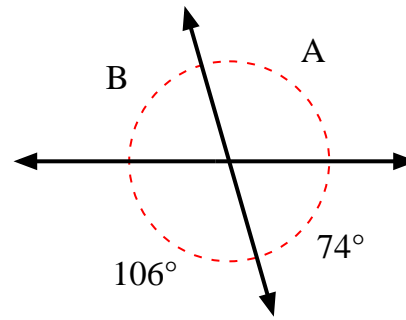

5)

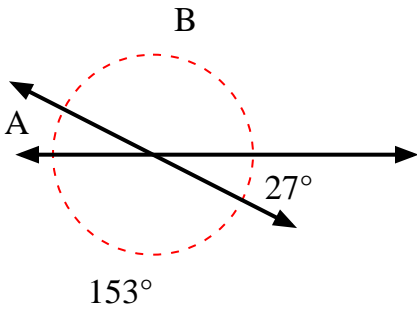

6)

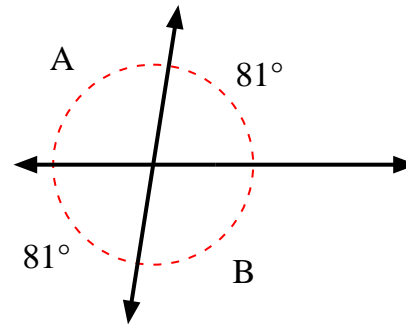

7)

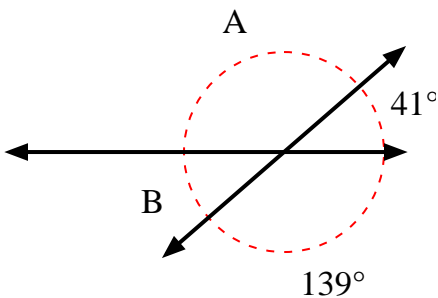

8)

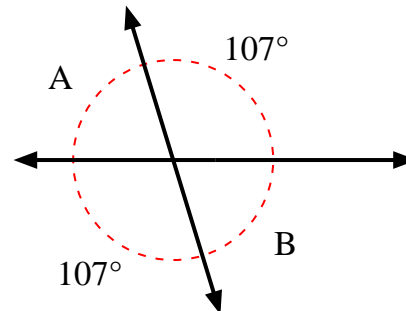

Answers

1. _____
2. _____
3. _____
4. _____
5. _____
6. _____
7. _____
8. _____

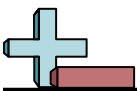

Find the value of angle 'A' and angle 'B'.

1)

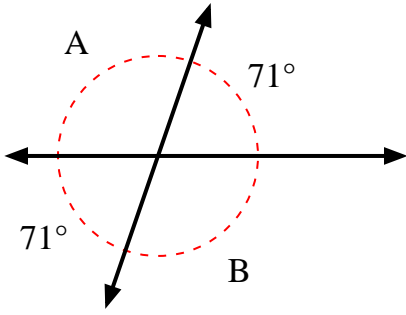

2)

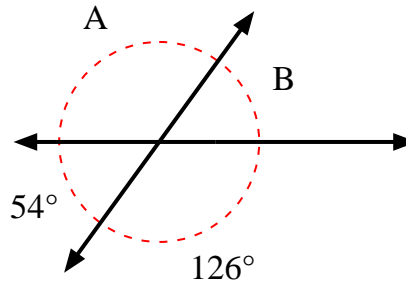

3)

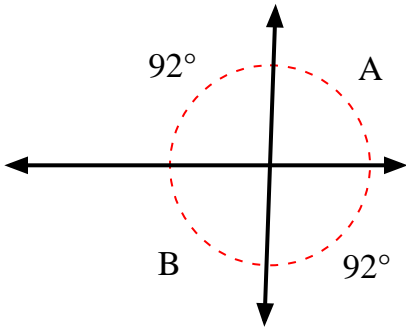

4)

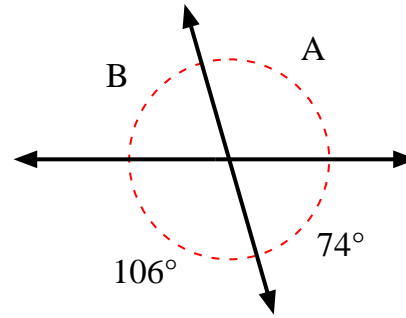

5)

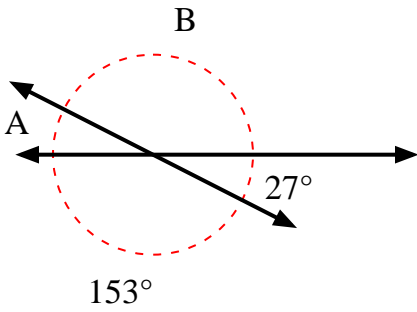

6)

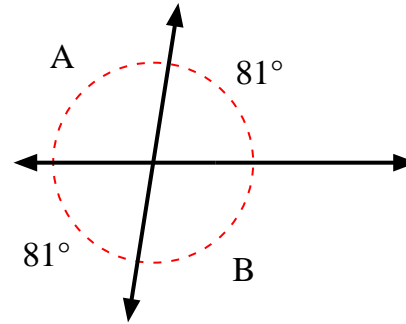

7)

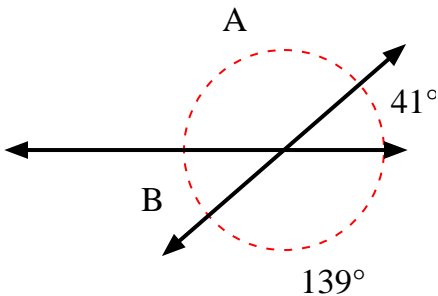

8)

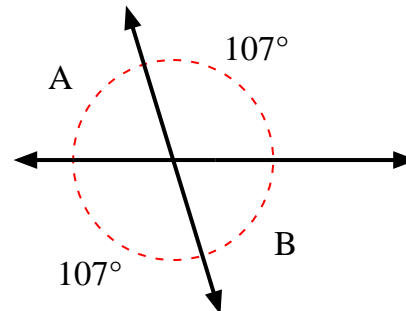

Answers

1.	109°	109°
2.	126°	54°
3.	88°	88°
4.	106°	74°
5.	27°	153°
6.	99°	99°
7.	139°	41°
8.	73°	73°